

# R2GATE<sup>®</sup> : Digital Dentistry

by MEGA'GEN

Turning imagination  
into reality  
since 2012



486	R2 STUDIO™ & R2GATE DOD
486	I. R2 STUDIO™
488	II. R2GATE DOD(Digital Oral Design)
491	R2GATE <sup>®</sup>
529	R2GATE Surgical KIT
571	MegaGen Digital Solution

# I. R2 STUDIO™

R2 STUDIO creates a Virtual Patient for full digital analysis & treatment realization

## Beyond CBCT....

A single CBCT scan collects extensive patient information, providing 3D images of the skeletal information, soft tissues, nerve pathways, skin.

## How does it differ from CBCT

However, R2 STUDIO extends this digital data collection to include a 3D facial scan & precise dentition, allowing the creation of the virtual patient that can reflect the patient's individual smile and overall character.



### CBCT

- Broad 20x20 FOV to create virtual patient
- 16 sec for 20 x 20 CBCT scanning
- Light-guided flexible FOV control

### 3D Facial scan

- Real 3D depth camera (1280x720) applied
- Independent photo taking module
- 5sec for full size of facial scanning
- 1800x848 full size 3D file (OBJ format)

### Object (impression)scan

- Handy scan process
- 20sec for impression scanning
- Auto STL converting process
- Easy to export model file (Open STL format)



- 14 sec for 20x20 CT scanning
- 20 sec for impression scanning
- 5 sec for 3D facial scanning
- 30 sec for data reconstruction
- Light-guided flexible FOV control
  - Max. 20cm x 20cm(300um)
  - Min. 4cm x 3cm(70um)

### 3D facial scan reflect the patient's individual smile and overall character

**20 x 20 CBCT taking**

- 16 sec for 20 x 20 CBCT scanning
- Precise & accurate scan

**Automatic Initial 3D facial-scan**

- Scan patient face during CBCT scan
- Auto-aligning function
- Auto-saved in object file format

- Real 3D depth camera (1280 x 720)
- Independent photo-taking module
- 5 sec for full-size facial scan
- 1800 x 848 full-size 3D file (OBJ format)

**Additional 3D smile scan**

- scan of full 3D smiling face
- Auto-saved in object file format



### R2 STUDIO creates digital model from an impression scan

**Impression scan & auto-converting to STL**

- 20 sec for impression scan
- Automatic conversion from dcm to STL
- Easy to extract teeth model

## Digital diagnosis & Treatment planner

# II. R2GATE® Digital Oral Design

Creates a fully virtual patient & applies digital diagnosis to evaluate & transfer virtual treatment into the perfect solution

### R2GATE Digital Oral Design(DOD)

R2GATE Digital Oral Design(DOD) is a digital planner for the whole dental team, so everyone understands their role and contribution to the treatment plan.



“Imagining the final goal is  
the starting point of treatment”

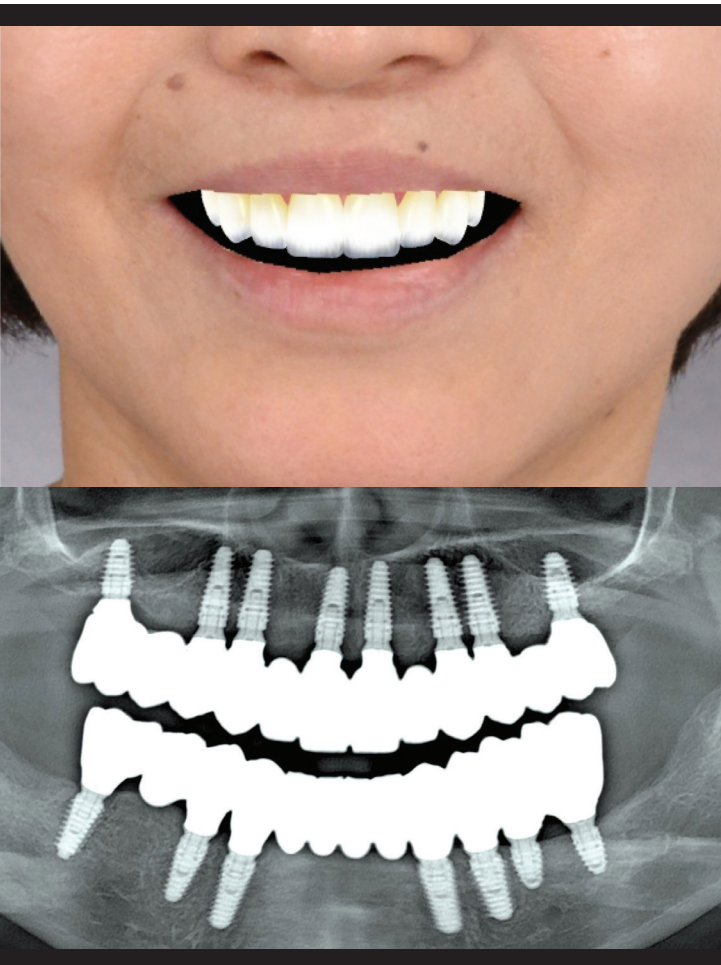

Adding the human element to CBCT technology

# R2 STUDIO™

by MEGA'GEN

Contain person's sensibility & Creating the Virtual Patient

**R2 STUDIO** creates a virtual patient for full  
digital analysis & treatment realization  
All-in-one: CBCT, PANO plus facial & impression CT scans

## R2GATE® Digital Oral Design

Create fully virtual patient(CBCT, facial & oral scans)  
Apply digital diagnosis to evaluate virtual treatment  
Transfer into perfect solutions

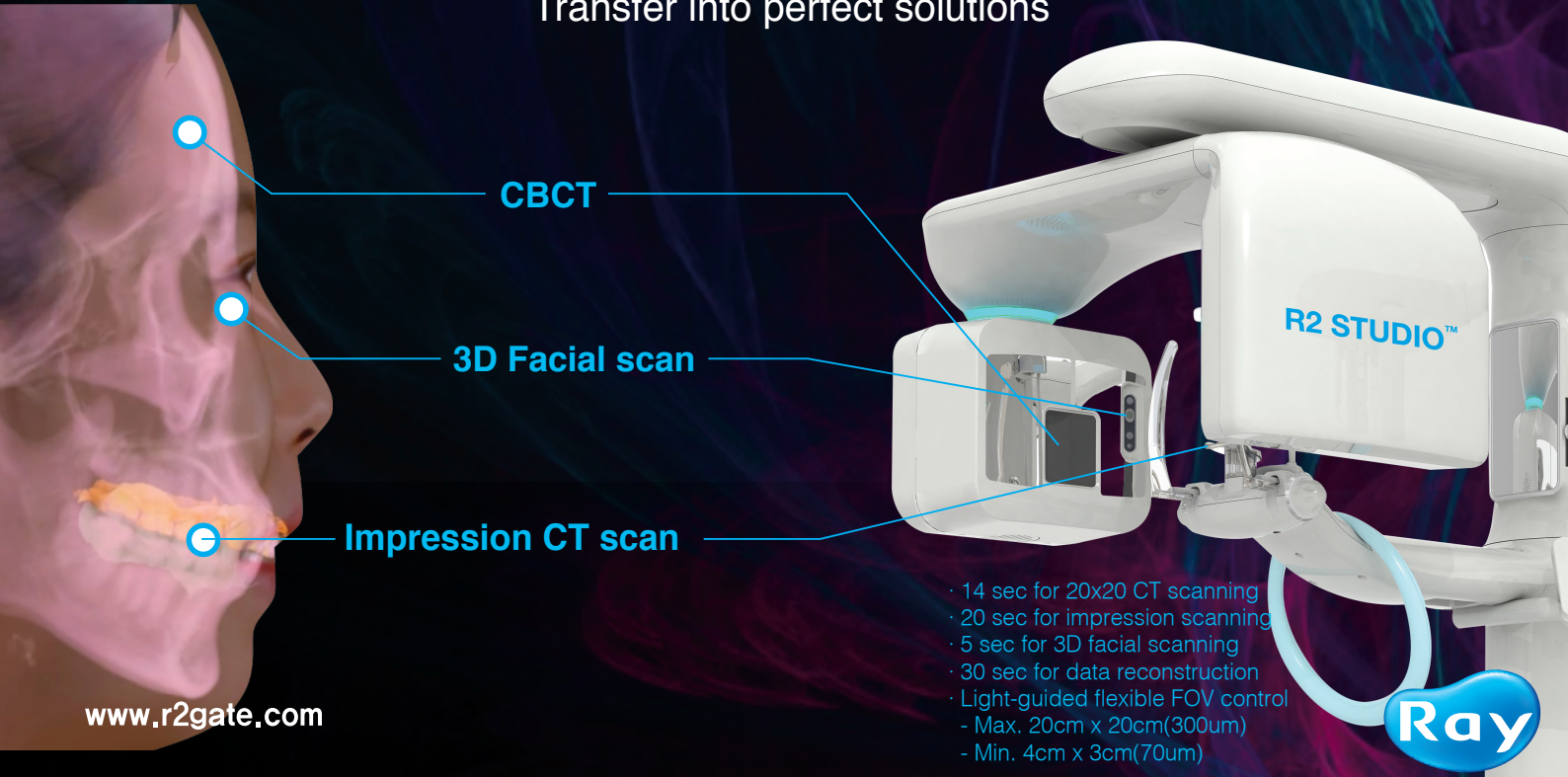

[www.r2gate.com](http://www.r2gate.com)

- 14 sec for 20x20 CT scanning
- 20 sec for impression scanning
- 5 sec for 3D facial scanning
- 30 sec for data reconstruction
- Light-guided flexible FOV control
  - Max. 20cm x 20cm(300um)
  - Min. 4cm x 3cm(70um)

**Ray**

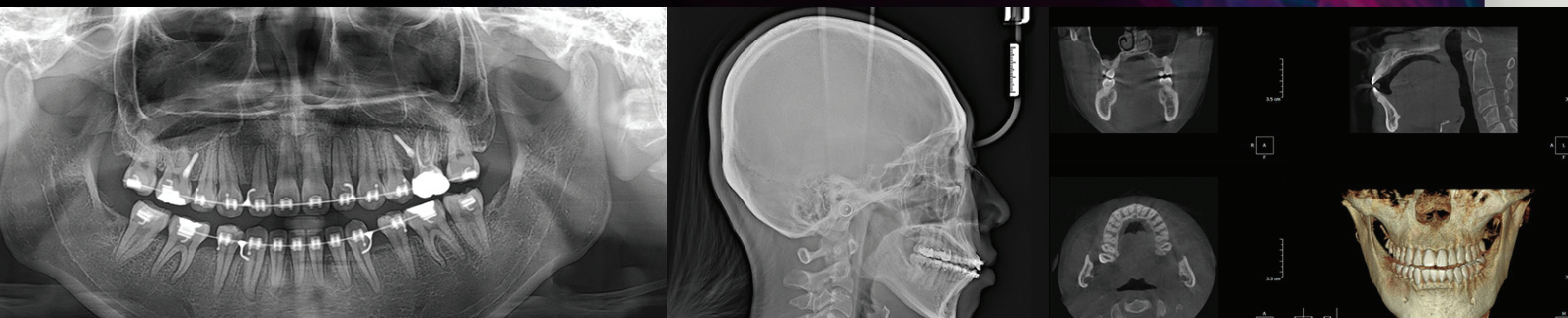

# R2GATE®

by MEGA'GEN

Turning imagination into reality

SINCE 2012

492	<b>What is R2GATE®</b>
493	<b>I. Digital EYE</b>
494	<b>II. One-DAY Implant</b>
496	<b>R2 Guide™</b>
496	<b>I. Advantage of R2 Guide</b>
500	<b>II. R2 Guided Surgery</b>
509	<b>R2 Digital Center</b>
509	<b>I. Various R2GATE Services</b>
510	<b>II. R2GATE Order Process</b>
512	<b>R2GATE Lite™</b>
517	<b>Clinical Case</b>

# What is R2GATE®

R2GATE is an innovative implant diagnostic software that analyses the oral condition and it shows the best option for implant treatment.

## CBCT (Dicom)

CBCT is the most efficient method for implant diagnosis. Through CBCT, you can easily identify the shape of the bone and other skeletal structures. But it has an original distortion and not accurate enough for complete treatment planning by itself.

## Digital EYE (Bone)

After intuitively checking the shape and density of bone via Digital Eye, you can obtain strong initial stability by customizing the drilling sequence. The software also provides a guideline for whether immediate loading is possible or not.

## STL (Soft tissue & teeth)

R2GATE merges the STL (3D scanning of model or impression) with the CBCT file to overcome the CBCT's limitations such as Metal Scattering and distortion. STL intuitively shows the gingiva and neighboring teeth.

## Top-Down Treatment planning

The purpose of implant treatment is to recover lost and functionless teeth. With R2GATE, you can select the ideal position of an implant by checking the crown design, and occlusion with neighboring and antagonist teeth.

The most innovative and intuitive diagnosis software for Dental implant planning in the world.

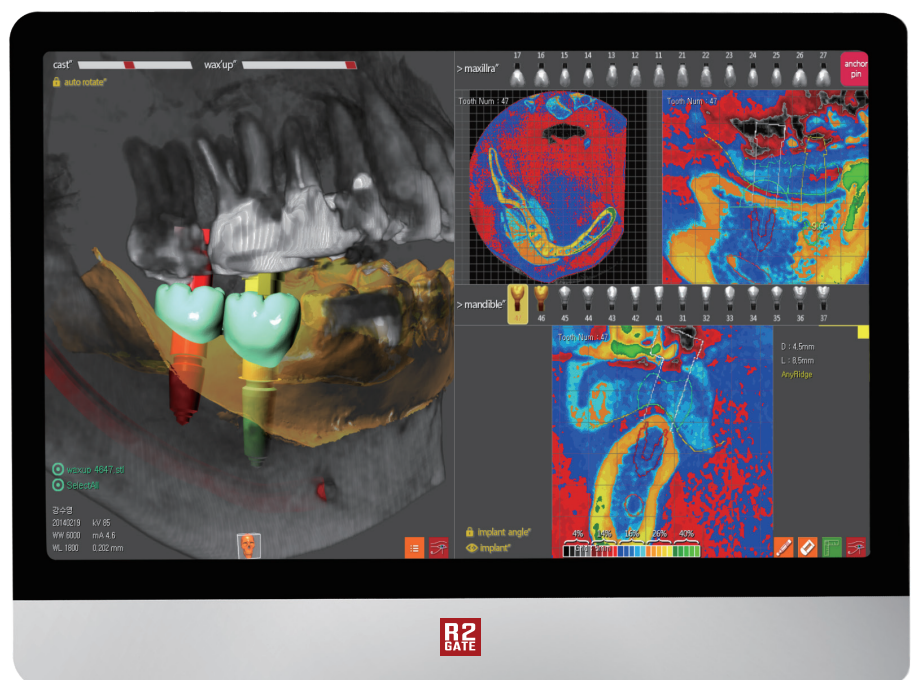

# I. Digital EYE™

Does your CBCT show you right information?

## Black and White? It's only 5%

Regular black and white CBCT analyzes the data in 256-level of shades. We can only detect 16 levels with naked eyes. R2GATE's Digital EYE regenerates 256 shades into color to deliver much more detailed, intuitive bone condition. It standardizes the brightness level that various CT equipment has and provides objective HOUNS FIELD UNIT. It significantly differs from the color that other CT data provides. Based on this information, you can decide implant position and size and its drilling sequence for the initial stability of the implant.

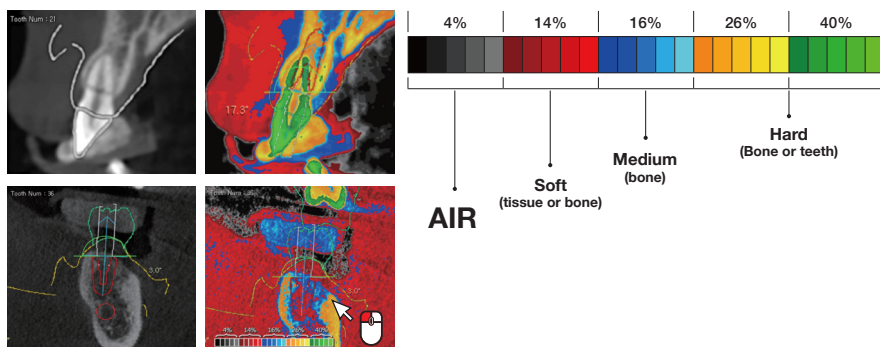

## Re-arrange of DICOM files for standardization.

Windowing function standardizes the brightness level that different CT equipment has and provides objective HOUNSFIELD UNIT. It significantly differs from the color that other CT data provides. Based on this information, you can decide implant position and size and the drilling sequence for the initial stability of the implant.

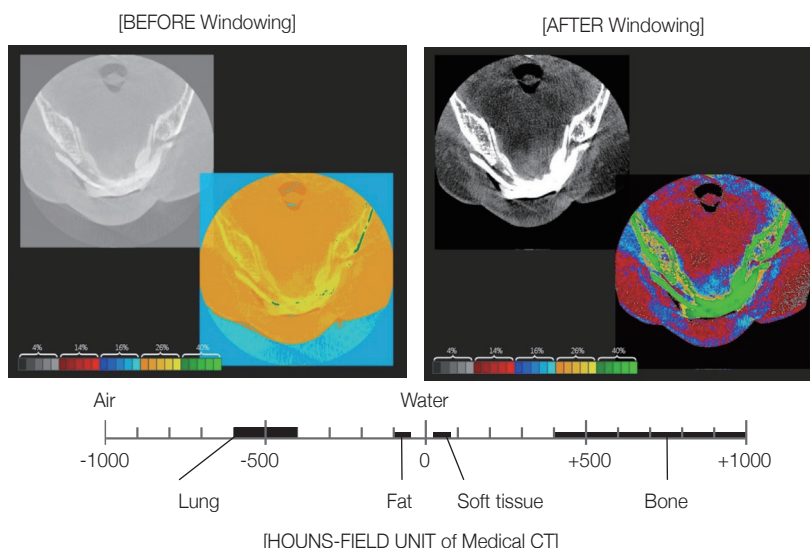

# II. ONE-DAY IMPLANT™

Get your implant and prosthetics in one day!



## Digital EYE™

Provides the predictable indications for Immediate loading. According to the bone density and R2GATE treatment planning, patients can have customized abutments before the surgery, and it can be placed right after the implant surgery.









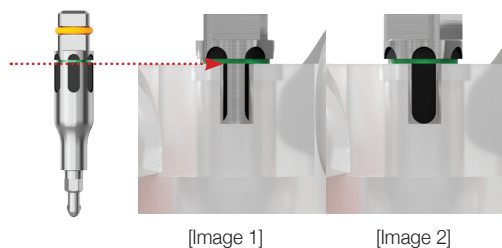

## Place a Fixture as it is planned

Completely connect the Handpiece carrier into a fixture, and drill it down as it is planned using your R2 Guide

- a. Depth of a fixture align the upper line of Handpiece Carrier with Guide Window as [Image 1]
- b. Matching internal hex of a fixture fill the window with the green part of a carrier body as [Image 2]



## Prosthetics can be manufactured as single, bridge, or screw-retained type according to your preferences.

<b>Cementation type</b>	 <ul style="list-style-type: none"> <li>- Customized Abutment</li> <li>- PMMA Temporary</li> </ul>	 
<b>Screw retained type</b>	 <ul style="list-style-type: none"> <li>- Ti-Base</li> <li>- PMMA CAD/CAM Provisional restoration.</li> </ul>	 
<b>Over-Denture type</b>	 <ul style="list-style-type: none"> <li>- Stock abutment</li> <li>- Customized abutment</li> <li>- 3D Printed Denture</li> </ul>	 

# R2GATE® is already tried and trusted world wide.

Japan, China, Taiwan, Thailand, USA, UAE, Romania, Italy, Netherland,  
Australia, Germany, UK, Russia, Ukraina, Turkey...  
Doctors are using R2GATE through out 50 countries.



**R2  
GATE**

2013 ~ 2021

**138,253**  
cases

Delivered to  
world wide

**384,572**  
Implants

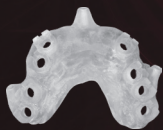

**128,190**  
Prosthesis



# R2 Guide™

## I. Advantage of R2 Guide™

Experience the most innovative implant guide surgery!  
Virtual planning becomes a reality.

### R2 Guide doesn't need a metal sleeve or spoons.

It has the internal-structure for drill stopper and hex controller. R2 Guide surgery is more convenient and precise.

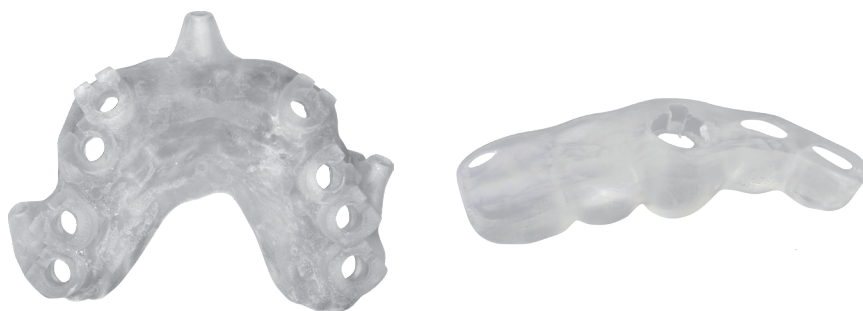

### Precise R2 Guide using 3D Printer.

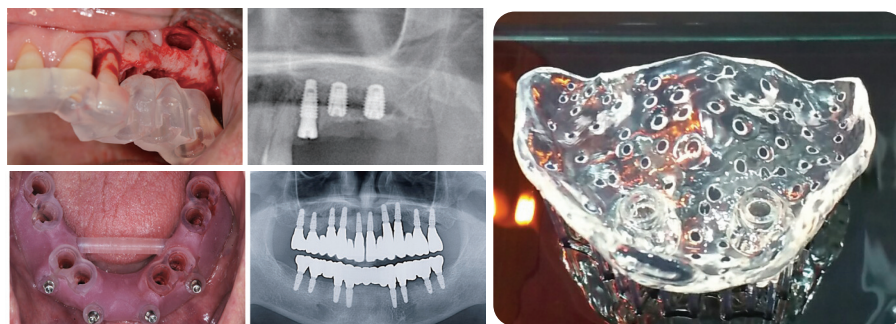

R2 Guides are designed directly based on your diagnosis and are printed by 3D Printer.

The unique structures of R2 Guide(for drill stopper, implant position, and hex control)are printed as one-body for improved precision and convenience.

# I. Advantage of R2 Guide™

**R2GATE integrated with Major implant systems.**

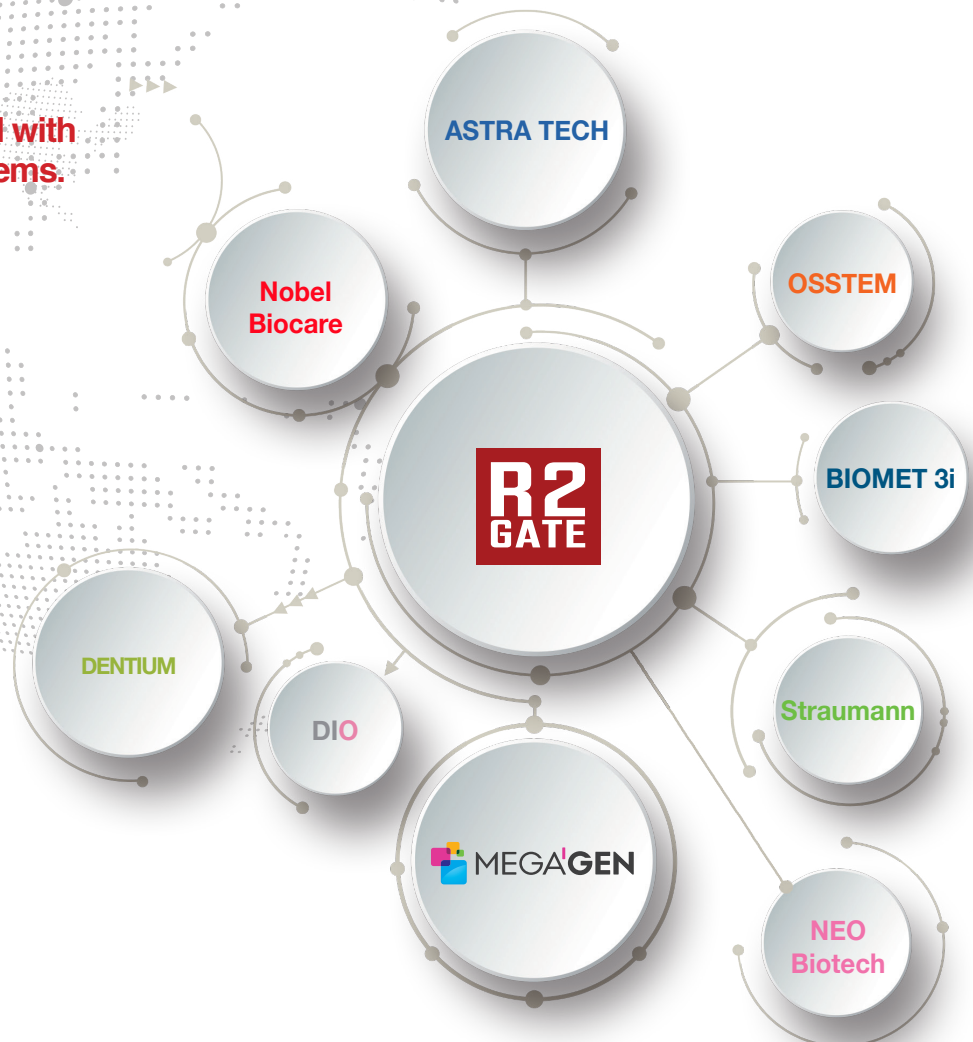

**R2 Surgical Kits are available!**

Full Kit and Universal Kit are available.

The full kit consists of a complete set of drills and system-specific implant carriers.

The Universal kit consists of drills from initial to 2.8 drills for any implant systems.

The implant carrier and disposable drills may be added as your option.



R2 Full Surgical KIT (MegaGen system only)



R2 Universal KIT

## ►► Simple and Practical R2 Universal KIT

Flexible kit for all implant systems

### Simple and practical **Universal Kit**

R2GATE Universal Kit includes essential guide drills and tools that can be used for various implant systems. Final drills and other necessary tools can be added for your preferred implant system.

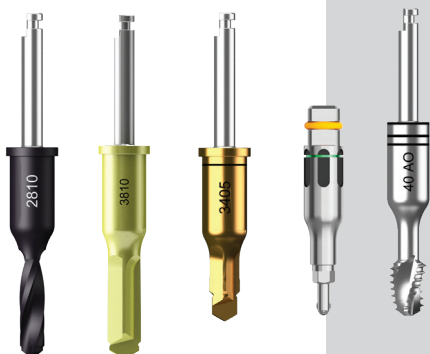

### **Add optional Tools** for your preferred implant system

You can add optional tools like implant carrier, tap drill, cortical bone drill and more for your preference. Refer to MegaGen Implant Catalogue for more information.

## Must have Accessory kit



### R2 Narrow Guide kit for Mini System

Are you planning to use for a Mini implant? Are you worried about the surgery because of narrow surgical space? Narrow Guide Kit with  $\varnothing 3.5\text{mm}$  drill core is designed to overcome narrow surgical spaces such as anterior mandibular, narrow distance between adjacent teeth or adjacent implants.



R2 Anchor Kit

### R2 Anchor kit For the fixation of fully edentulous guid

R2 Anchor Kit is used to fix fully edentulous R2 Guide in the mouth.

#### Anchor Pin:

Put R2 Guide and Putty Bite together and put it into patient's mouth. Let the patient bite firmly. Then, insert an anchor pin into the pin holes on the guide and fix them using a driver. If bone density is dense, Slightly drilling to penetrate cortical bone area with 2.0 x 13.0mm drill will be helpful for better fixation.

#### Anchor Screw:

For fully edentulous guide, placing fixtures and connecting anchor screw in a triangular form is highly recommended for better fixation as the image below.

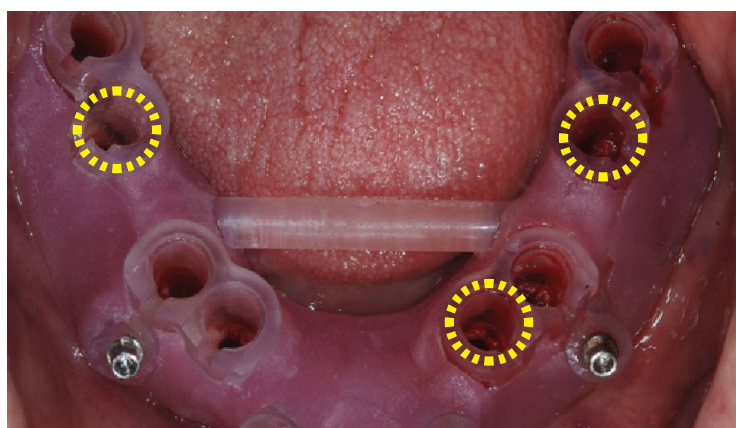

When regular fixture and wide fixture are needed to place in edentulous case, there will be 2 set of R2 Guides for regular fixture and wide fixture placement. Anchor screw will provide same position of fixation for both of R2 Guides.

# II. R2 Guided Surgery

## 1. Preparations for R2 Guide™ Surgery

### 1 Package check

Check what are contained in the delivery package received from R2 Design Center.

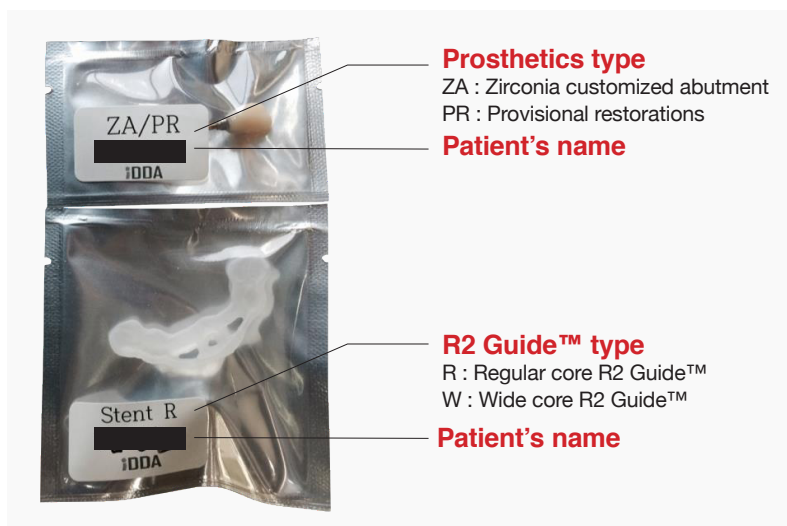

### 2 Received two R2 Guide™?

Do you plan to place a wide diameter fixture ? One is for regular diameter of drills and another is for wide diameter of drills & fixture insertion.



All diameter of general drill hole(core) and guide part of drills are 5.0mm. So from 3.5 to 4.5 diameter fixture can be placed through general drill hole. But In order to insert wide diameter fixture (over the 5.0mm), drill hole(core) should be made for wide diameter drilling and fixture insertion.

#### Drilling sequence:

Up to 4.3mm diameter of drilling, use the regular hole R2 Guide™ (marked "R"). Then that change to wide hole R2 Guide™ and continue to drill with bigger diameter drills.

### 3 Sterilization for R2 Guide™ and prostheses

Put the R2 Guide™ and all prosthetics into a bowl (jar) with an antiseptics (ex. Chlorhexidine Gluconate) for 30 minutes before surgery.



## ►► Types and retention of R2 Guide™

### 1. Tooth - supported type

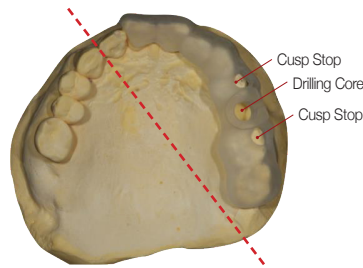

[Minimum size of model] Even its tooth support type R2 Guide™, 3/4 arch model is required for design and accurate retention.

**1~4 implants** The residual teeth are still remained around the implantation site. The Main retention of R2 Guide™ comes from the remaining teeth. So, with the larger number of remaining teeth, retention will be higher and more stable. The damage and porosity of the remaining teeth on the model are not acceptable for the design of R2 Guide™ and its adaptation.



\* Cusp Stop : To check the accuracy of R2 Guide™, Designer makes a few number of “Cusp stopper” on the cusp of the mesio-distal neighbor teeth. When R2 Guide™ is seated, check its fitness of contact between cusp and hole. There should not be a gap.

### 2. Dual - supported type

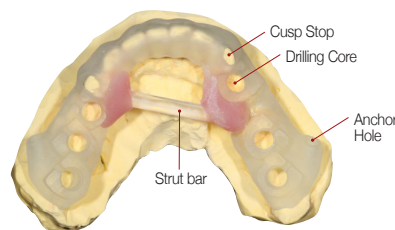

**Free-end case** Most of the free-end case, R2 GUIDE™ gets the retention from a remaining tooth and residual ridge. All anatomical forms of teeth, alveolar ridge, vestibule should be represented clearly on the model.

\* Anchor Hole : The anchor hole can be designed for additional retention. The location will be decided during diagnosis and confirmed by user. Ø 2.0 drilling might be required to insert anchor pin into the hard bone. (Maxillary anterior, Mandibulary regions).



### 3. Fully tissue - supported type

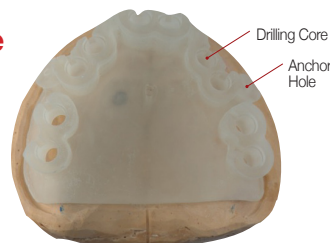

**Fully edentulous case** In the fully edentulous case, R2 Guide™ gets the support from the residual ridge and gets the retention from anchor pins. All anatomical structure (palatal, vestibular) should be represented clearly on the model.



\* Putty bite : Right initial positioning of R2 Guide™, putty bite will be provided. Combine putty bite and R2 Guide™ first than put it in the patient mouth together. Let the patient bite it strong and insert the anchor pin into each hole.

The distortion of the model is an important factor of the error on diagnosis and R2 Guide™. Please understand checking point of R2 Guide™ fabrication, and try to make accurate impression and model.

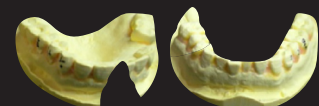

## 2. Adaptation of R2 Guide™ before surgery

This procedure is essential to check the accuracy of R2 Guide™.

### 1 Tooth & tissue supported type

**Check the “Cusp stop” of R2 Guide™** To check the accuracy of R2 Guide™, our designer makes a few number of “Cusp stoppers” on the cups of the neighboring teeth. When R2 Guide™ is seated, check its fitness between cusp and R2 Guide™ hole. There should not be any gaps.

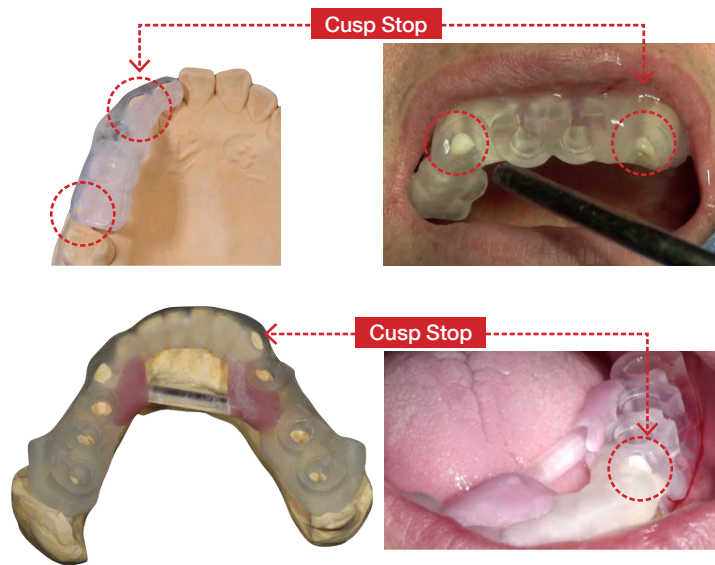

### 2 Fully tissue supported type

**Putty bite and Anchor pin** For an edentulous case, R2 Guide™ is seated using the putty bite and fixed with anchor pins specially designed for R2 Guide™ positioning.



1. The connected R2 Guide™ and the seating jig are delivered into the mouth together and seated.
2. Patient should bite with maximum occlusal force on the R2 Guide™ and seating jig.
3. Tighten the anchor pin using a hand driver.
4. 2.0mm drilling will be required in advance if the drilling point have a thick cortical bone.

## 3. Necessary items to produce R2 Guide™

### 1 R2 Tray used for taking CBCT

#### R2 Tray SE

- Tools for trimming the stopper in R2 Guide
- 10ea 1set

Ref.C

R2TRAYSE



### 2 Hole trimmer set for R2 Guide trimming

#### Stopper trimmer

- Tools for trimming the stopper in R2 Guide

Thread	Guide Diameter	Ref.C
Narrow	Ø3.5	AGHTN2
Regular	Ø5.0	AGHTR2
Wide	Ø6.5	AGHTW2



#### Hole trimmer

- Tool for trimming guide holes in R2 Guide

Thread	Guide Diameter	Ref.C
Narrow	Ø3.5	AGHTN3
Regular	Ø5.0	AGHTR3
Wide	Ø6.5	AGHTW3



#### Reamer Handle

- For length extension by connect to trimmer

Ref.C

TCMRH



### 3 Stent sleeve for guide

#### Stent Sleeve

- Stent sleeve for MegaGen implants in 3shape(implant studio) software
- 10ea 1set

Thread	Guide Diameter	Ref.C
Narrow	Ø3.5	R2SS35P
Regular	Ø5.0	R2SS50P
Wide	Ø6.5	R2SS65P



## 4. Basic principles of drilling with R2 Guide™

### No spoons, No sleeves

### Our guided drill design does not need spoons or sleeves

All of our drilling components from initial drill to implant carrier are designed as guide and drilling part. You do not need any additional sleeves or spoons, to shorten the surgery time.

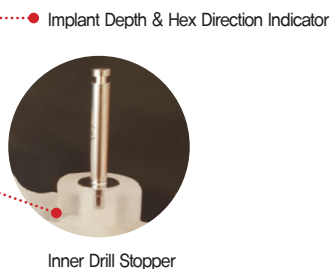
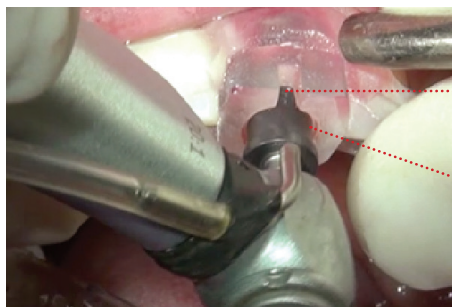

### Drilling Protocol

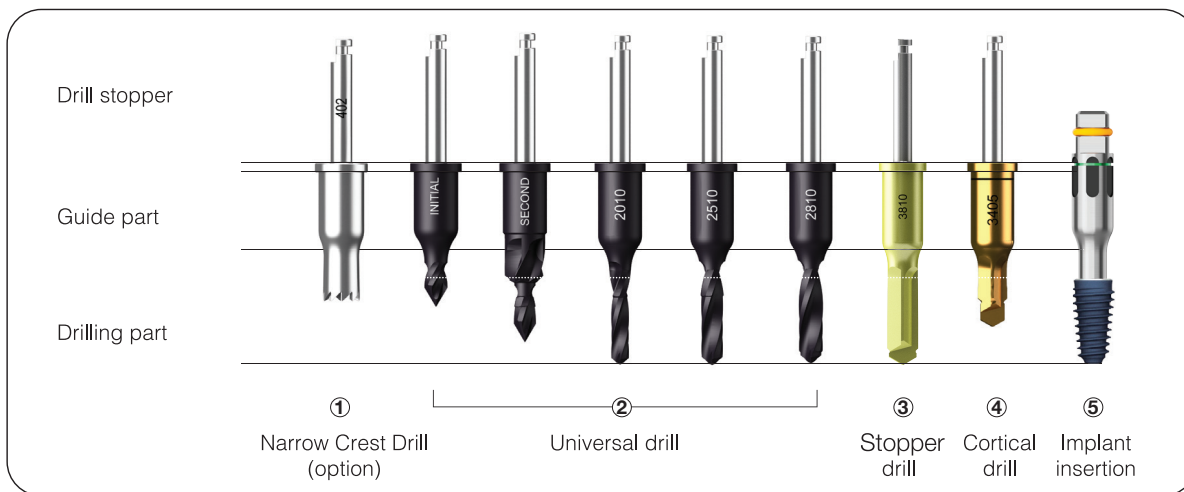

### Narrow Crest Drill for narrow or steep alveolar ridge.

If a regular drill is used on narrow or steep alveolar ridge cases, a drill may slip and the drilling path will be made in the wrong direction. In this case, use a narrow crest drill first and flatten the drilling area to prevent slipping.

#### How to use the Narrow Crest Drill.

- a. Counter-clockwise: Engage the blade onto the ridge by rotating a drill with less than 100 RPM
- b. Clockwise: Drill with 400~600 RPM
- c. Start a drilling sequence with initial drill
- d. You can collect bone by separating the drill body after drilling

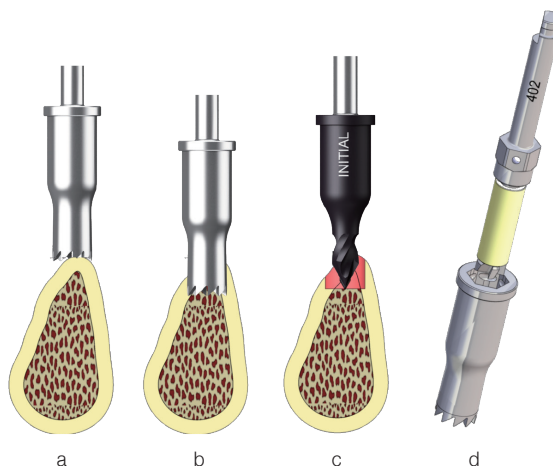

## Initial & 2<sup>nd</sup> Drilling

The 2<sup>nd</sup> drill also works as a profiler drill which removes excess bones above the fixture platform for a better connection of prosthetics. If bone density is dense or high resistance during drilling, stop 2<sup>nd</sup> drilling protocol and repeat 2<sup>nd</sup> drilling protocol right before fixture placement.

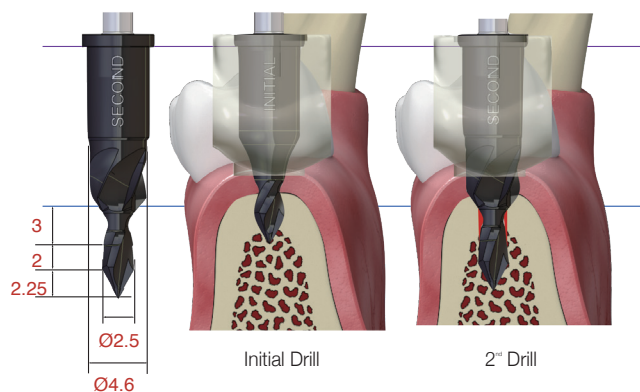

## Crucial Step: Basic drilling

Narrow Ø2.0 diameter drilling is very important to complete the coronal path of the drill. Especially when the guide core is short due to thick gingiva, gradual drilling to secure the depth of a fixture is essential for successful surgery.

Eg) When placing a 11.5mm length fixture  
 Narrow drill ► initial Drill ► 2nd drill ► 2.0x7 ► 2.0x8.5  
 ► 2.0x10 ► 2.0x11.5 ► 2.5x11.5 ► 2.8x11.5 ► Final drill ► Cortical bone drill

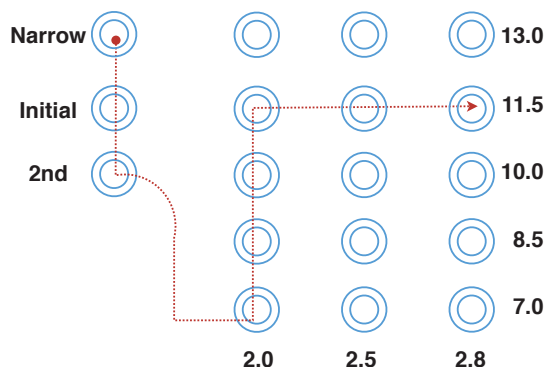

## Slow drilling in a Drill Core

Before drilling, you have to check the guide part of drill to be inserted into the drill core of guide completely. when drill is in right position, start drilling with recommended RPM [300 ~ 500 RPM]

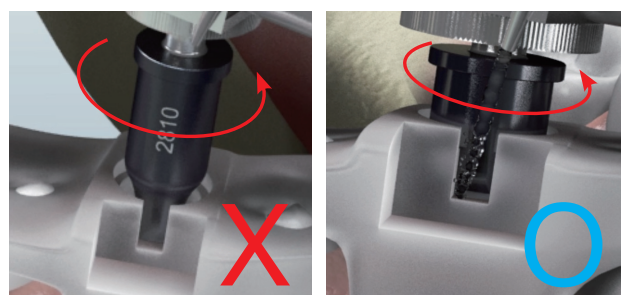

## Slow UP & DOWN Motion

Drilling must be done in the order of increasing the depth of osteotomy and then widening the diameter according to the suggested drilling protocol. Keep repeating up and down motion slowly until the drill stopper touches the stopper position on the guide.

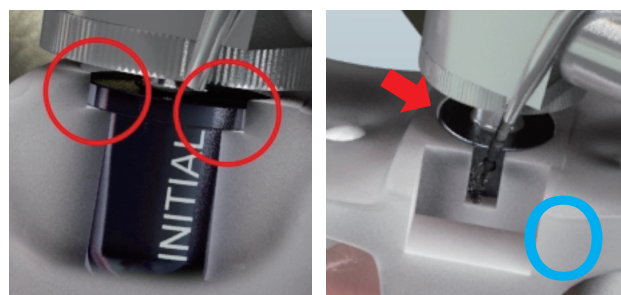

## Deliver Fixture as planned

Make sure to connect Handpiece Carrier onto a fixture and deliver it through the R2GATE Guide as planned.

### a. Fixture depth control

Align the upper line of the Handpiece Carrier with the Guide Window as [Image 1]

### b. Hex position control

Align the green part of Handpiece Carrier as [Image 2] to make hex position in buccal direction.

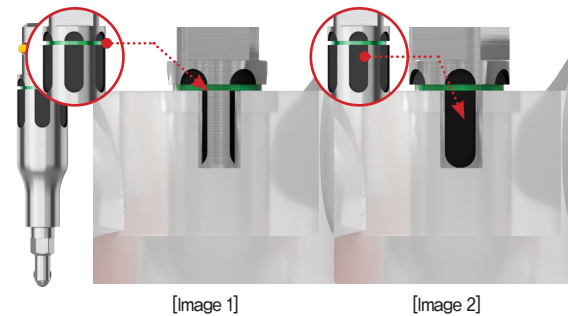

## We provide a general standard for immediate loading [ISQ & ITV]

If you use AnyRidge System, the recommended ITV (Initial Torque Value) and ISQ (Implant Stability Quotient) for immediate loading are  $ITV = 45\text{Ncm}/ISQ=75$  or above. These values are only for the AnyRidge system and cannot be applied to other systems.

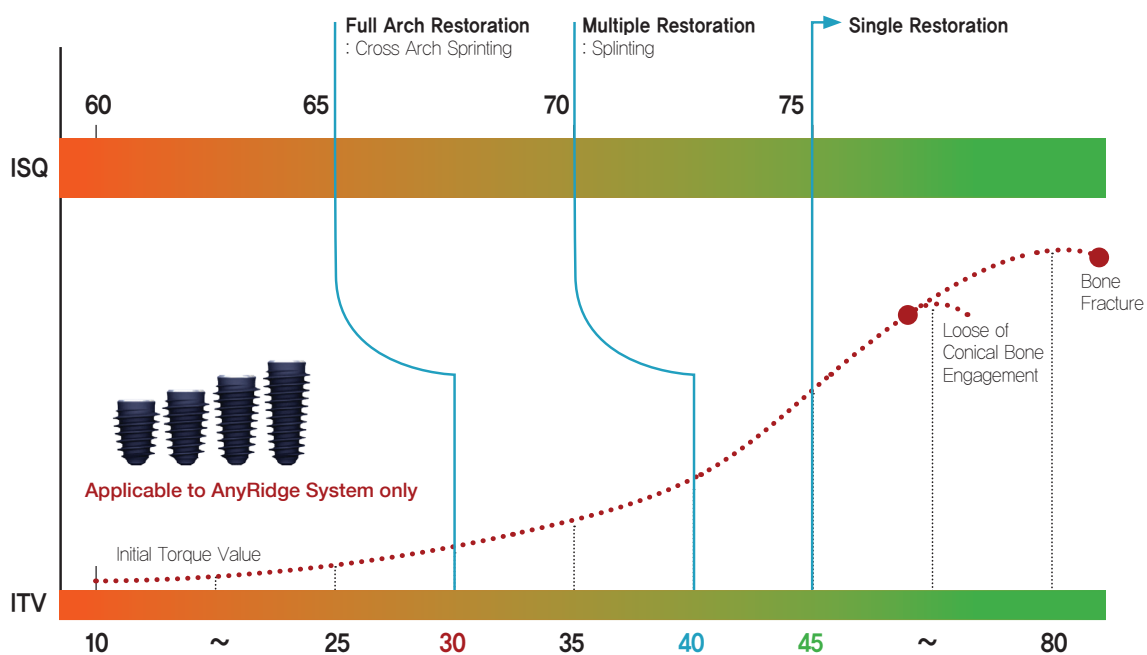

## 5. Recommended condition for ONE-DAY IMPLANT & immediate loading

According to our own clinical experiences & data, we strongly recommend to check two values : Insertion Torque & ISQ value.

- 1 Insertion Torque value : more than 45Ncm

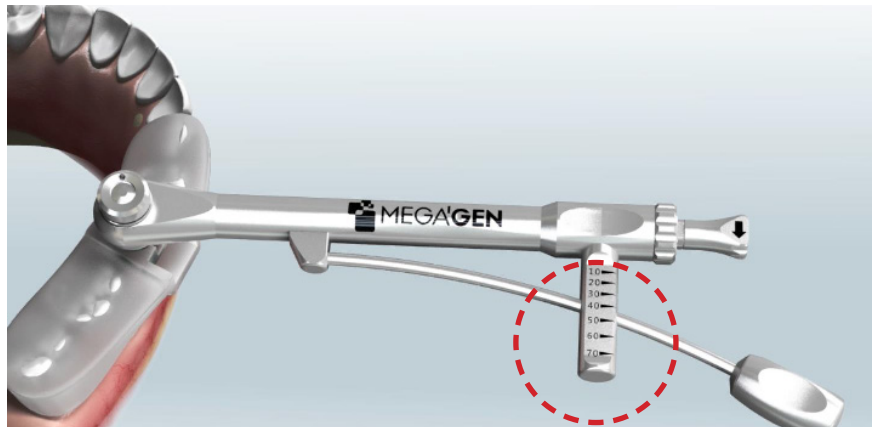

Available on our R2 Universal Kit.

- 2 ISQ value: more than 75 ISQ value

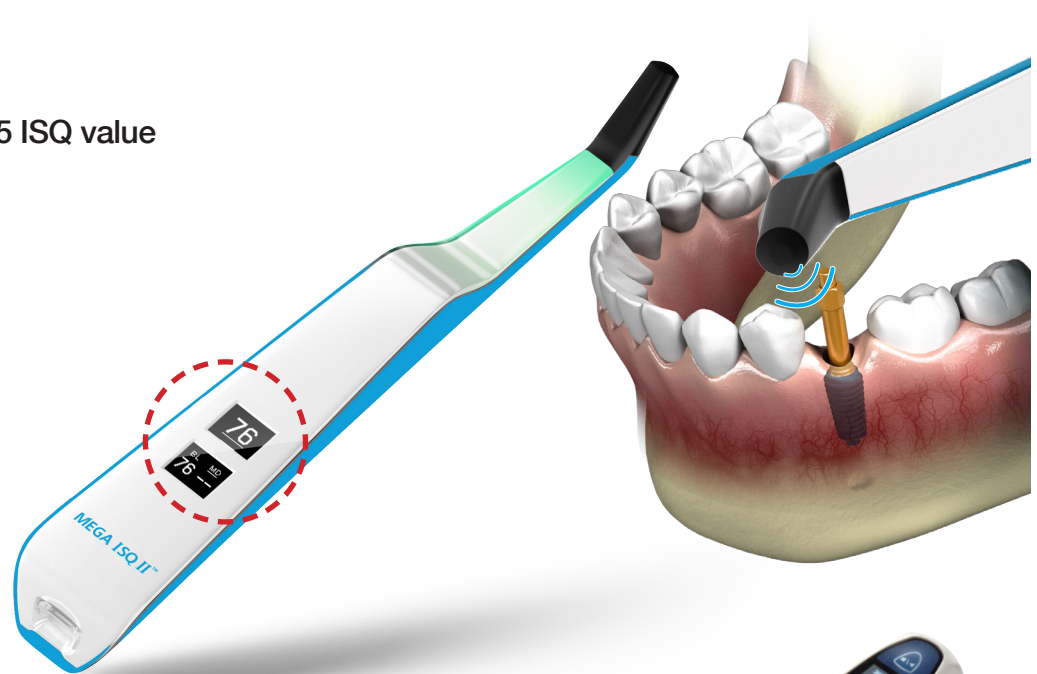

### R2 Digital Center

To have stable ISQ value, we recommend to use MEG-TORQ to fasten a smartpeg with 5 Ncm torque force consistently.



*Moment of Choice!*

**R2GATE**®  
by MEGA'GEN

Experience the future with  
**R2GATE**®

**Blue pill...**  
stay in the present

**Digital EYE™ ;**  
**Color-coded analysis of bone morphology & density**

Although CBCT uses 256 shades of B&W, the human eye can only detect 16(6%). Therefore, Digital EYE converts the CBCT shades into full color with a standardized brightness, allowing intuitive analysis of the bone condition to position & size the implant, determine the drill sequence, and predict the initial stability for immediate loading(ONE-DAY IMPLANT™).

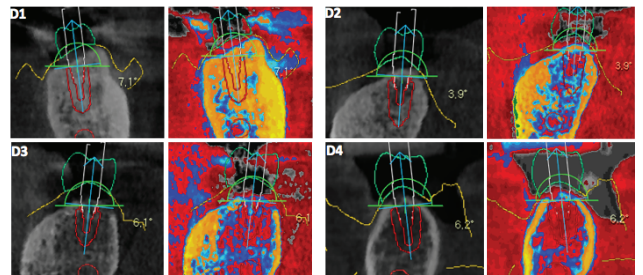

**Creating the reality of ONE-DAY Teeth & Digital All-on-4(6)**

- accurate diagnosis
- reduced chair-time
- minimally invasive surgery
- immediate loading using digital prosthesis
- excellent clinical results

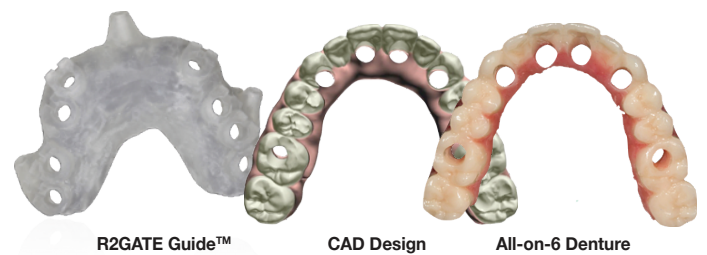

**Convenient drilling system**

- All drills combine drill, guide, & drill stopper into one-body
- No need for metal sleeves or spoons!
- Shorter surgery time!
- Disposable final drill provided for each surgery to optimize initial stability

**Compatible with all major implant systems**

**Significant cost savings!**

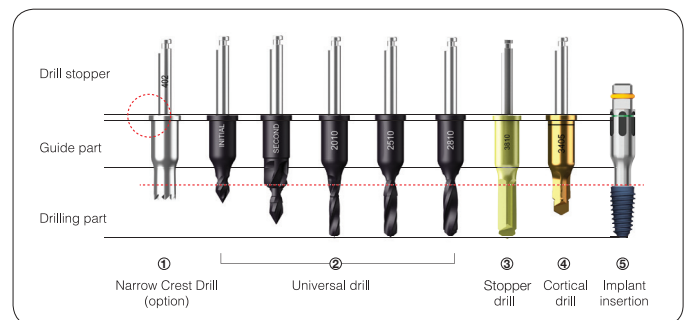

# R2 Digital Center

## I. Various R2GATE Services

We provide various R2GATE Services. Enjoy them conveniently.



### R2GATE® Planning Service

**Optimal Implant positioning basis on the TOP-Down concept.**

R2GATE allows you to do Prosthetic driven Treatment Planning for optimal positioning of the implant. It provides an eidetic view of all elements that you need for implant practice as CBCT, STL, and Prosthetic design before surgery

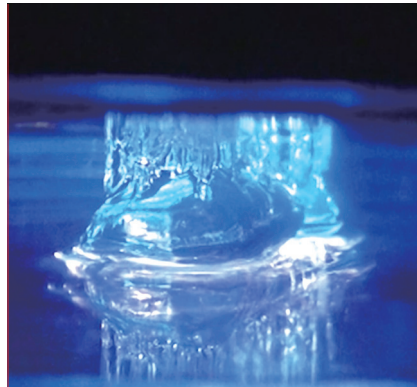

### R2 Guide™ Service

**Realize the Tx.planning perfectly.**

The surgical guide will be made using state of the art 3D printing technology with the result of Tx.planning. R2 Guide completes your daily implant practice without uncertainty.



### R2GATE®

**ONE-DAY IMPLANT® service.**

Under certain conditions, various prostheses may be delivered on the same day as surgery. Recover function & aesthetics immediately!

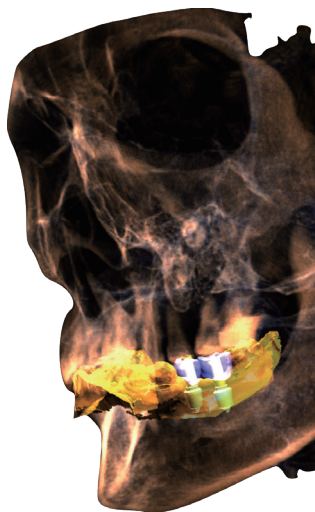

## II. R2GATE Order process

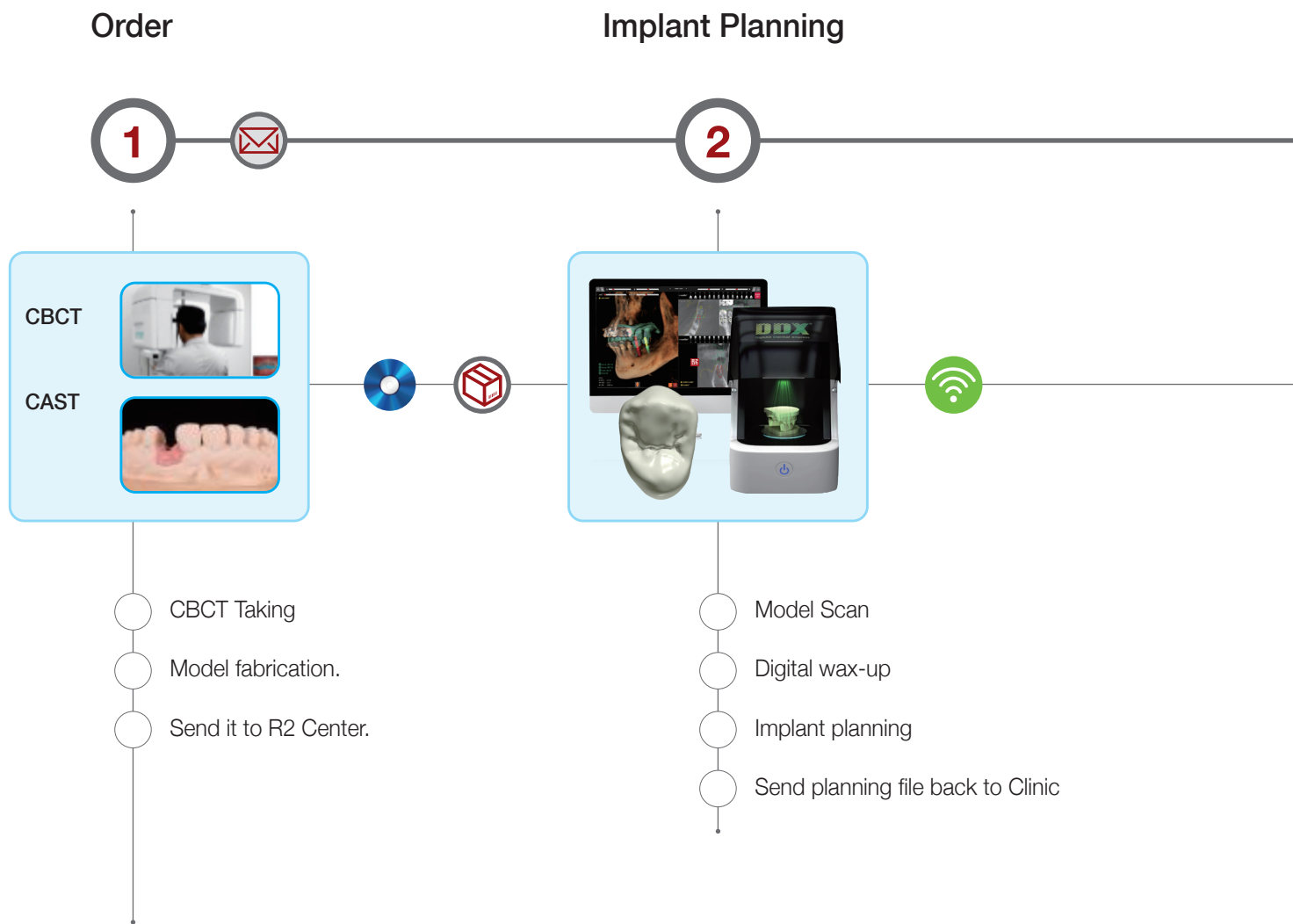



**Caution!**  
Ask R2 Tray to local R2 Digital Center before placing an order

If a patient is partially edentulous or if there are multiple teeth with metal fillings or restorations, R2 Tray must be used. R2 tray must be sent to R2 Digital Center along with study models and bite registration.

Simple order process : R2GATE Service is very simple, fast and cost effective.

We have world-wide R2 Digital Center network. Please contact to nearest Digital Center or MegaGen distributors at applicable countries.

### User Confirmation

### Manufacturing

### Delivery

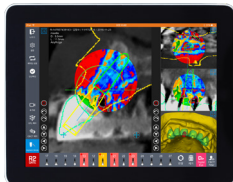
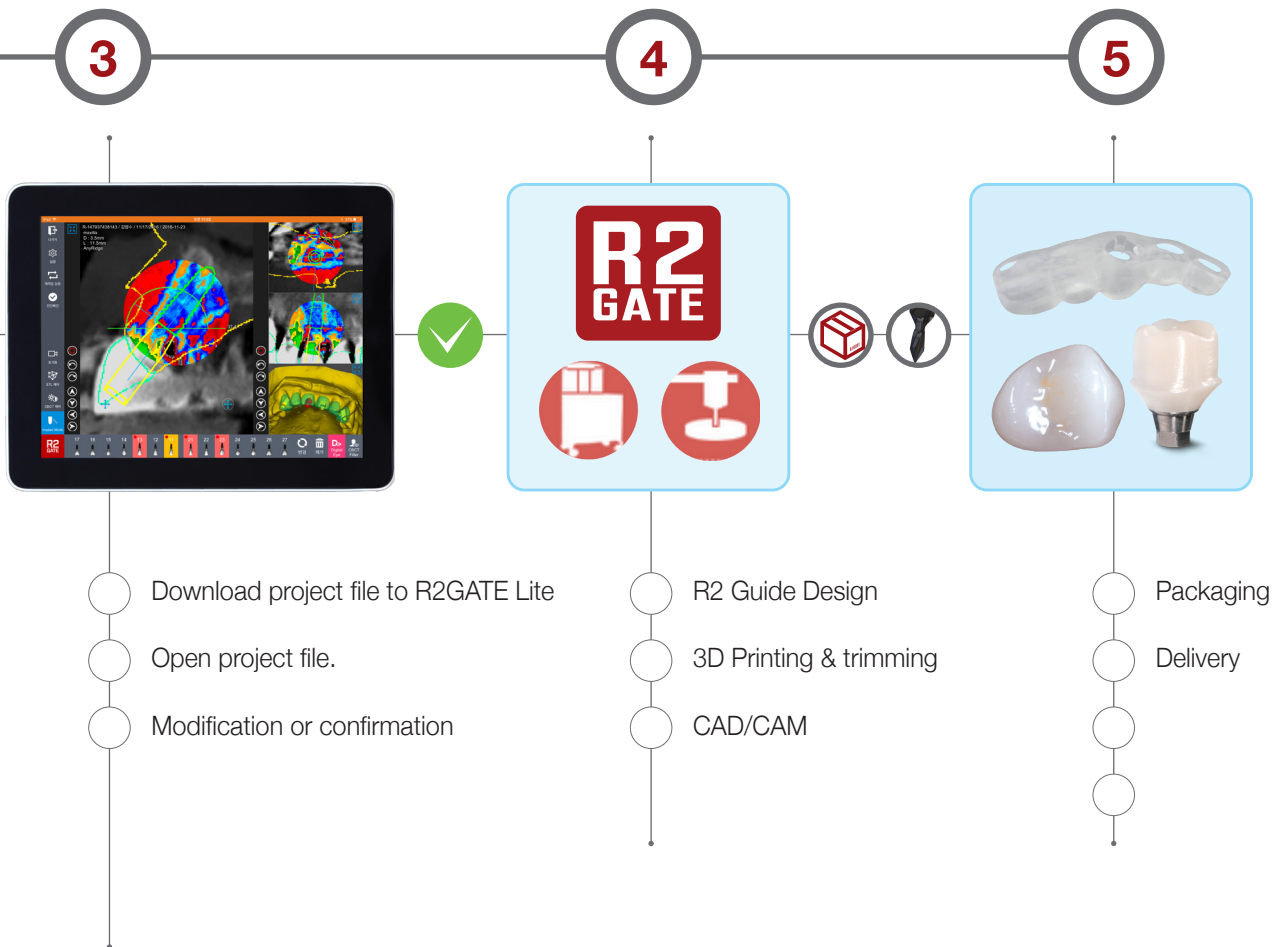

**Your confirmation is the most important to shorten the delivery time.**

Diagnostic information sent to R2GATE lite can be confirmed. Corrected and approved data are saved as project files and transferred to the R2 Digital Center R2GATE Lite is the essential option for you.

# R2GATE Lite™

Meet the most innovative implant diagnostic software program in the most innovative way!

## Whenever, Where-ever!

Diagnostic information sent to R2GATE Lite can be confirmed by the dentist immediately. Corrected and approved data are saved as project files and transferred to the R2 Digital Center in real time.

## Communication with R2GATE Lite™

Throughout consultation about implant treatment with a patient, ensuring the patient clearly understands their oral condition and the future possible outcome of the treatment is a major factor in assuring patient satisfaction. Using R2GATE Lite on IPAD, the doctor can easily show the visual information on treatment planning from diagnosis through to the optimal treatment.



# Communication and Design efficiency

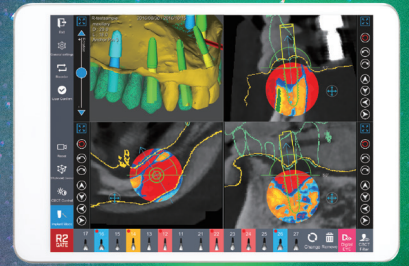

With R2GATE Lite, everywhere it becomes your clinic for you & your patients. You can check, edit, confirm, or send a file to R2GATE Design Center at anytime, and anywhere.



the world's first  
Mobile Diagnostic Software

# R2GATE Lite™

# R2GATE Lite™

## Light and Upgrade

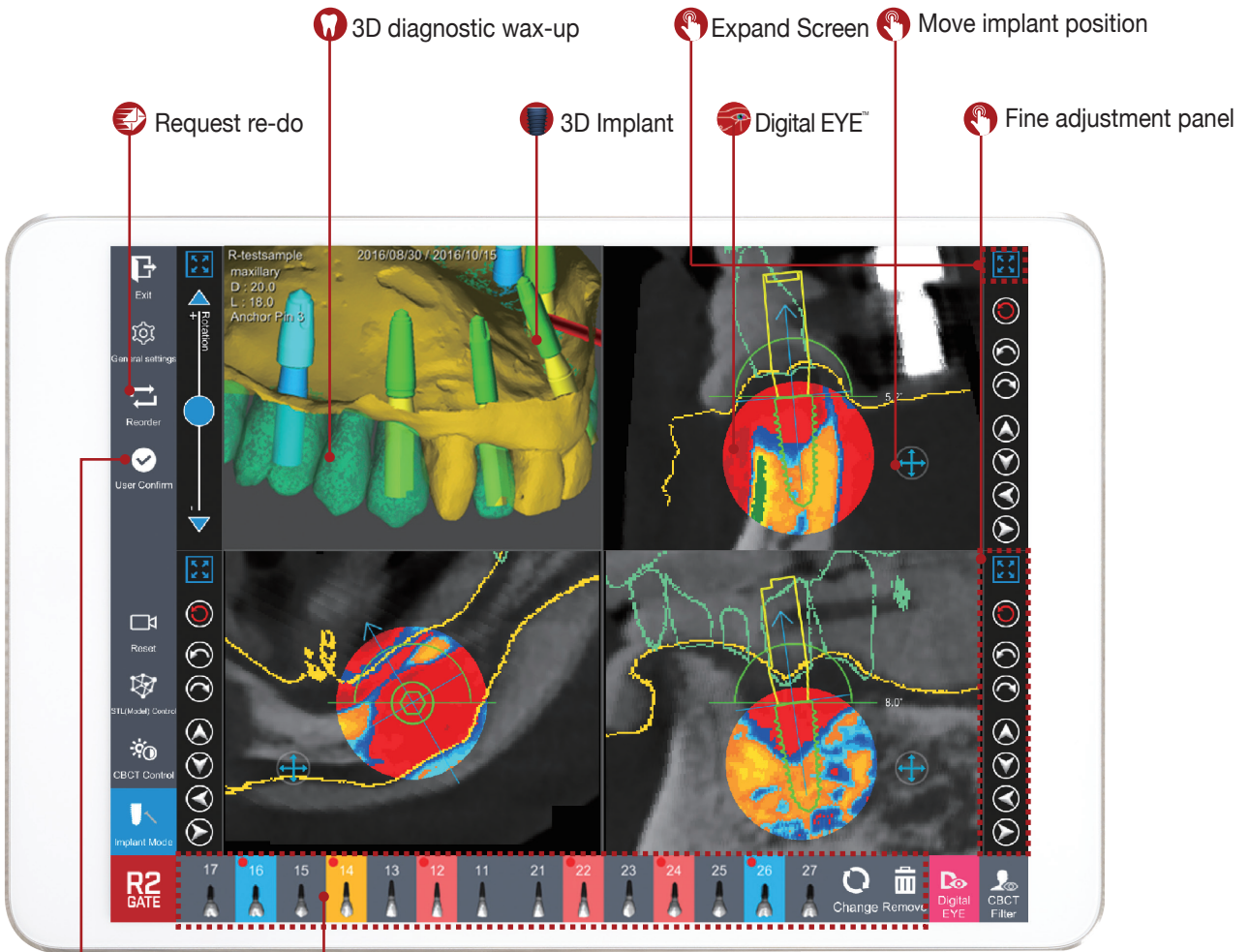

- Request re-do
- 3D diagnostic wax-up
- 3D Implant
- Digital EYE™
- Fine adjustment panel
- Expand Screen
- Move implant position

Case Confirm

Select or Edit Implant

You can easily select, add, remove, or modify an implant. Using the international teeth numbering system, you can edit an implant that is currently loaded on the planning.

Pink represents an implant that is already planned, yellow indicates selected implant.

Blue indicates implant newly created implant by user.

Red dot in the selected implant indicates that user has modified the size, position, or angle from initial loading stage.

- Expand screen
- Initialize
- Tilt to left
- Tilt to right
- Move upward
- Move downward
- Move left
- Move right





### 3 essential key factors for implant diagnosis : Bone, soft tissue, teeth

For an ideal implant treatment, cortical bone, soft tissue, and prosthetics must work together.

R2GATE intuitively analyzes and shows the condition of cortical bone and soft tissue, and optimize prosthetic outcome for ideal treatment planning.

For multiple implant cases especially, the distance between implants/platform level and the implant axis angle can be easily understood beforehand for simpler treatment and prosthetic procedure.

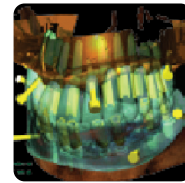
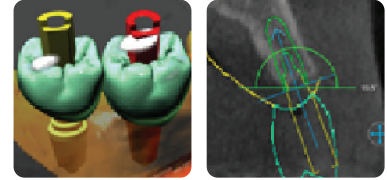

### Digital EYE™

Standard black and white CT analyses the data in 256 shade levels, but human eyes only detect 16 levels with the naked eye.

R2GATE Digital EYE regenerates 256 shades into color to deliver a much more detailed and intuitively understandable guideline of the bone condition.

Also, it standardizes the brightness level that each CT equipment has and provides an objective Houns Field Unit. This significantly differs from the color that other CT data provides.

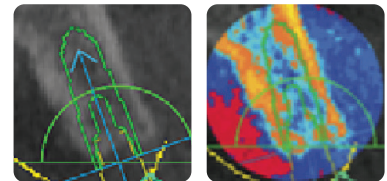

### Easily shift, zoom in, zoom out, rotate with your finger

Easily change the position of the implant with your finger.

- Implant rotation: Lightly touch the screen and drag to rotate the implant.
- Implant shift: Lightly touch the ⊕ sign from the lower part of the screen, and drag to move the implant position.
- Zoom in & out: You can easily zoom in & out by using two fingers. Please use the "Moving Key" on the right corner of the screen if accurate adjustment is needed.

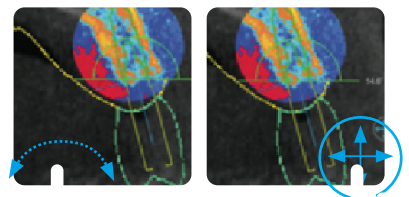

### Fast and easy diagnosis check

You can confirm the diagnosis immediately by using the "User Confirm" function, or you can send the changes to the center. If you need to revise the model or the implant placement site, you can use the "Diagnosis Reconfirm" function to conveniently receive the diagnosis again.

#### Auto detecting

All the information that you have done through R2GATE Lite is automatically saved, and all confirmation or modified data will be sent to R2GATE Design Center.

# R2GATE Lite™

Meet the most innovative  
implant diagnostic software program in  
the most innovative way!

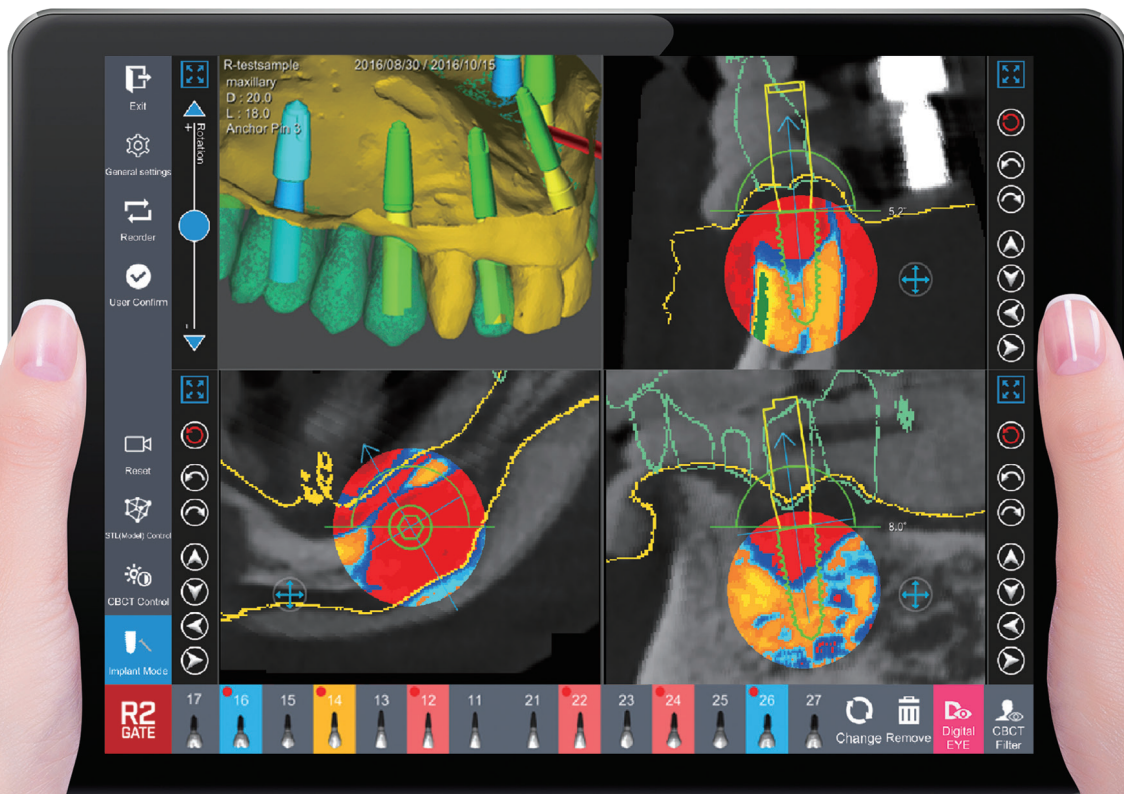



## Clinical Case Report

Turning your imagination into reality

- Diagnosis & Treatment planning with R2GATE® and the clinical result
- Understanding and Purpose of Surgical Stent Surgery
- Clinical cases using an R2 Guide™ (1)
- Clinical cases using an R2 Guide™ (2)

- Author : *Dr.Jong Cheol Kim (The investor of R2GATE)*

# 1. Diagnosis & Treatment planning with R2GATE® and the clinical result - Dr. Jong-Cheol Kim

## Implant surgical procedure using guided static surgery

A 68 year old patient presented with the necessity of full mouth reconstruction. Unfortunately, he suffered from pneumonia and had to be hospitalized for about 6 months before the implant surgery. There was partial maxillary bone loss as shown in the panorama below taken before surgery. The patient would need GBR procedure to recover lost bone. At a late stage, the patient and his family changed their minds, preferring minimally invasive implant surgery after the long-term hospitalization due to pneumonia. In this situation, flapless surgery would offer the least invasive option if no GBR treatment was to be carried out. In this case, direct surgery would not be possible, and a blind technique would be required. Under such conditions, most doctors would want to simulate the surgery using all available options - CT images, prognosis program and customized guided drills. This is the story of an approach to guided static surgery converging CBCT (a media device) and CAD/CAM technology through this clinical case.



These are the photos and panoramas of the patient's oral cavity after 6 months hospitalization. We need to take alginate or rubber impressions for a full mouth reconstruction using guided surgery. The plaster model is sent to a digital center which produces the stents. 3 different materials based on the plaster model are sent back to us. Using a wax rim, the operator will decide the implantation position of the upper central incisor, and mark the extension line connected to central line of the face. The facial soft tissue can also be controlled and the bite plane of the deployment angle can be decided by editing the wax rim. We can refer the arrangements of the stent from these procedures. The position of the CR and vertical dimension are decided with a Gothic arch attached to the plaster model. We can decide the so called 'verti-centric' with a Gothic arch.



These pictures show the Gothic arch traces that indicate the movements of the mandible and the stable mandibular position. Proper VD (Vertical Distance) has been decided. Bite material will be poured into the oral cavity with the Gothic arch to record the 'verti-centric', then a CBCT image is taken. The pictures to the right are the CBCT photos with the Gothic arch. Preparation is now complete.



CBCT images are sent to the digital center server online, the Gothic tray containing verti-centric movements, the plaster model and the wax rim with facial information will be also sent by regular mail. Specialists at the digital center will start mounting on an Articulator based on the received materials. These pictures show the model mounting procedure. The maxillary and mandibular plaster models, the inter-maxillary space and the wax rim information can be digitalized using a dental scanner.

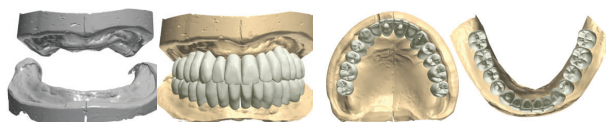

These pictures show the diagnostic wax-up made based on scanned materials by Dental CAD saving a lot of time. All the information regarding the diagnostic wax-up can be opened as a file on R2GATE® program.

The principle of R2GATE® developed by Megagen implant Co., Ltd. is layering the DICOM (CBCT) image and the STL file (attained by scan and CAD). By layering the images, we can simulate the implantation based on the prosthetic appliance position seeing the diagnostic wax-up, the plaster model image and the bone condition at the same time. This makes mock surgery using the 'Top-Down treatment' idea possible. The operator's surgical concept can be simulated using two- and three-dimensional images. Below pictures show the simulated implantation of 10 maxillary teeth and 8 mandibular teeth. Another advantage of R2GATE® is the actualization of the mock surgery results as opposed to other CT viewers which only check the result via a monitor. This simulation result can be extracted as a file that can be used to design with Dental CAD.

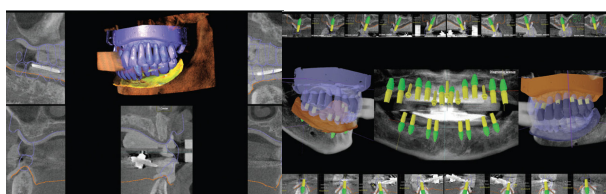

These pictures show the full denture drilling guide designed based on the sources from digital CAD. Not only the drilling guide holes, but also the pin holes needed to fix the stent can be designed. In addition



## *MegaGen's R2 Guide™ is very accurate*

the customized abutment and prosthetic appliance can be designed. This means we can recover function and aesthetics immediately by placing the upper prosthetic appliance (if the case of suitable ISQ value) because an upper prosthetic appliance fitting exactly to the implants placed through the customized drill guide can be produced in advance. The CAM method currently attracts more users than CAD. CAM has 2 different ways of manufacturing - milling or 3D printing. This will be expanded in the following pages.



These pictures show the maxillary and mandibular implant drill guides produced by 3D printing. The pictures below show the customized zirconia abutments and temporary crowns produced by milling. As a result, the dentist can receive a drilling guide and a maxillary prosthetic appliance, and may decide whether to connect the maxillary prosthetic appliance or not depending on the ISQ value. The bone can be drilled through the fixed guided stent using anchor pins as you see in the pictures below. This shows the result of flapless minimally invasive implant surgery.

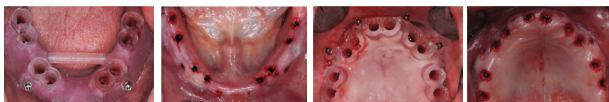

Panoramas and pictures of 10 implants placed using a maxillary stent in the same way. The customized zirconia abutment and the temporary crowns produced in advance were placed after observing a satisfactory ISQ value.

The satisfied CT results can be observed.

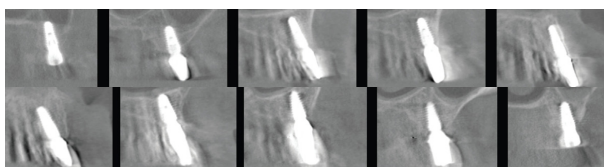
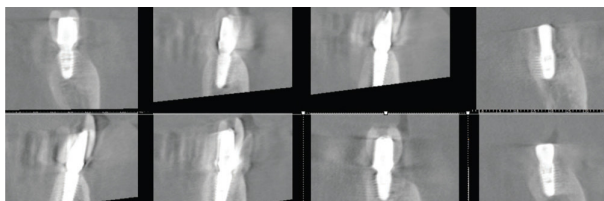
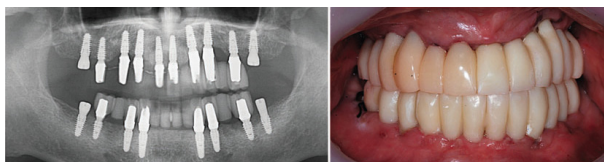

Maxillary CT after the surgery

You can check the satisfactory CT results.



We produced the final prosthesis after 3 months. At this time, the mandible has zirconia abutments and temporary PMMA crowns have been placed in the mandible to allow further recovery of the patient.

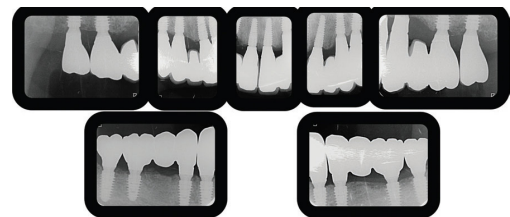

This shows panoramas and standard radiographs at 1 month after the final prosthesis was placed. This has been a brief introduction to the general process of guided static surgery using R2GATE®. Due to time & space limitations, this is only an overview - we hope you will be stimulated to ask for more information about R2GATE® and CAD/CAM. Over the following pages, we will elaborate on the explanation and focus on the prognosis before surgery with R2GATE®, on surgical simulation, and hope that the whole process will be clear.

## 2. Understanding and Purpose of Surgical Stent Surgery

- Dr. Jong-Cheol Kim

As you can see on the previous pages, R2GATE's virtual simulation has the advantage of combining DICOM (CBCT) and STL files enabling the depiction of the overall status of the patient with real time digital videos before commencing surgery. This handy function means that dentists can decide the optimal position for placing implant fixtures and allow a quick overview of the diagnostic wax-up, the soft tissue and the bone. In other words, virtual simulation has reached an outstanding level for finding implant positions as close as possible to real surgery using CAD/ CAM. A simple schematic diagram follows below.

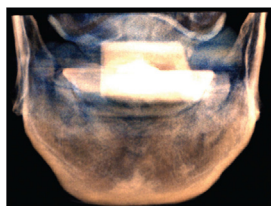

**CBCT**

DICOM: Digital Imaging & Communications in Medicine

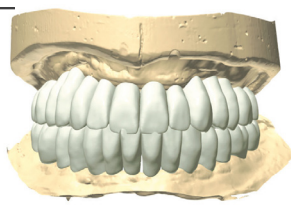

**STL**

Standard Tessellation Language

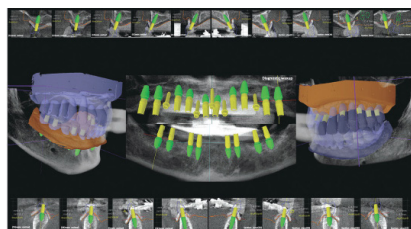

**Virtual Surgery**



**R2 Guide™ surgery**

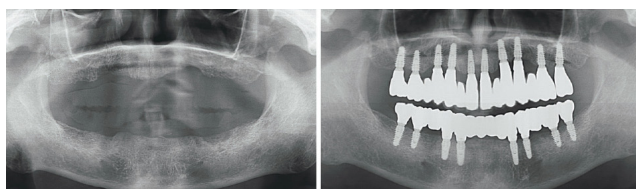

This schematic method of stent surgery can be either 'Open flap surgery' or 'Flapless surgery'. Most clinicians think that 'Guided surgery' means "Flapless surgery". With this concept, the range of clinical applications for drill guides is extremely limited in cases of the lack of hard and soft bone tissue. If instead, one thinks of 'Guided surgery' as correct "implant position", it makes the application much

more useful in many clinical cases. Here are some examples.

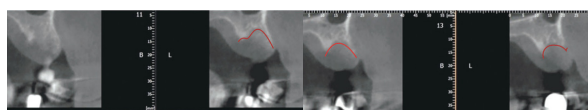

This case is a 56-year-old female with a right maxillary second premolar defect. As can be seen in radiographs, the mesiodistal "Interproximal bone level" area seems adequate, but the faciolingual area shows significant bone loss.

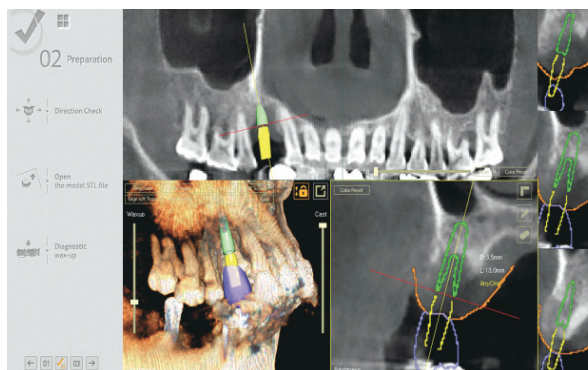

The defect of the mesiodistal space is quite wide, making it difficult to decide the position of both prosthesis and implantation. With R2GATE however, true virtual patient simulation procedures can be carried out. The dentist is able to determine surgical options before surgery thanks to the simulation available with R2GATE.



*R2 Guide™ does a very important role for the implant cases with defects*

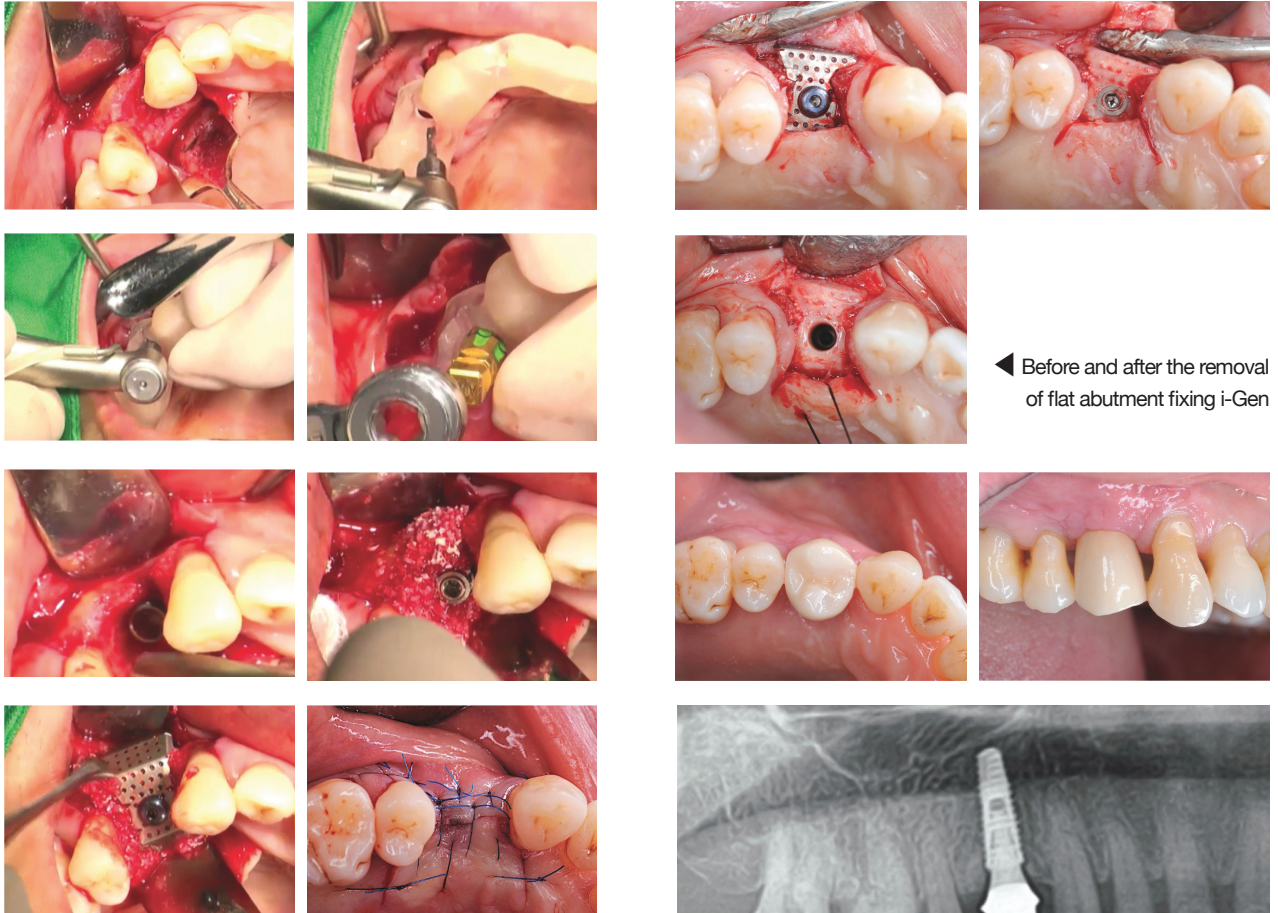

◀ Before and after the removal of flat abutment fixing i-Gen

The position of the implants can be determined using R2GATE® and easily configured – use of an R2 Guide™ and Ti-mesh (i-Gen) is decided with the virtual diagnostic procedure. Final suturing is also shown.

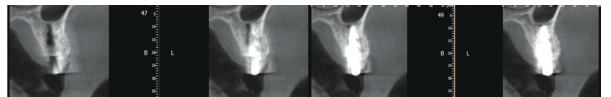

4 months after the surgery

R2 Guide™ guided surgery is '3D positioning and realization of implantation' as you can see in the clinical case presented. Over the next pages, we will introduce a variety of clinical cases using an R2 Guide™.

### 3. Clinical cases using an R2 Guide™ (1) - Dr. Jong-Cheol Kim

As described earlier, the Clinical Significance of Guided Surgery using R2GATE® software and an R2 Guide™ is 3D positioning and its realization with implants. Now I would like to present some clinical cases using R2GATE® software and an R2 Guide™.

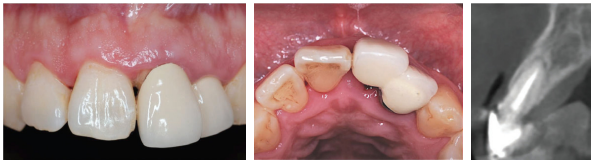

The patient above came to the clinic complaining of movement in the #21 tooth. Cervical caries was immediately identified with the CT. This patient requested rapid, aesthetic, functional recovery over the shortest possible duration of treatments. We planned immediate loading of zirconia customized abutment and a temporary crown, if excellent initial stability could be obtained after implantation using R2GATE® and an R2 Guide™. 2 preparations were needed in the clinic.

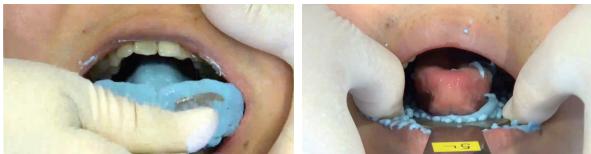

Firstly, an alginate impression of both the upper / lower jaw was taken and stone casts produced. Accurate impressions and stone casts are essential as they are the basis for all the material (data) using R2GATE®.



Second a CBCT scan is needed. As shown in these pictures, the patient bites a unique tray (R2 tray) and the CBCT scan is shot. This R2 tray is utilized as a standard of superposition of the CBCT and the STL files. These 2 processes are preoperative in the clinic. Stone casts can be sent via parcel service and the CBCT file via internet to the R2GATE® Center.

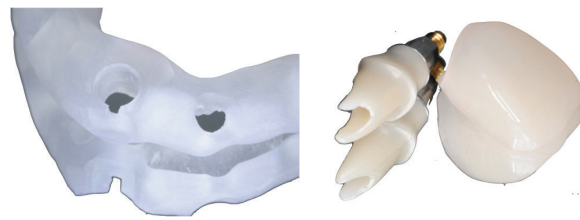

The R2 Guide™ and prosthesis are produced with this data.

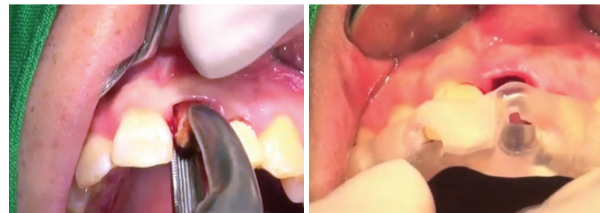

This R2 Guide™ must be placed carefully to avoid damaging the buccal alveolar bone following the tooth extraction.



The drilling may then be performed to the size of the implant using drills exclusive for the R2 Guide™ system exactly according to our virtually planned surgery in R2GATE®. As the pictures show, complete drilling processes are recommended to be performed following the guide part of the R2 Guide™.

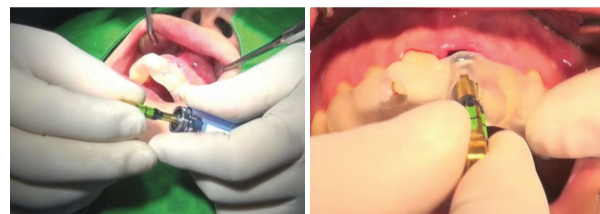

Pick up the implant after finishing drilling, using the hand ratchet connector. The correct combination between ratchet connector and fixture should be accurately checked. The fixture can then be placed in the prepared site after this confirmation.



## *You can use the R2 Guide™ for Immediate Implant Placement case*

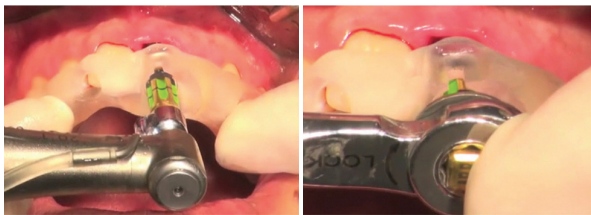

We recommend the use of an implant motor. Once the implant is almost completely placed with the motor, the final vertical depth and position of the implant should be completed using a torque wrench to match exactly with the virtual plan.



The pre-made customized zirconia abutment may be connected after bone grafting the gap between the socket and the fixture.



The location of the fixture may be matched to the R2GATE™ plan by matching the window of the R2 Guide™ and the black line and green code on the ratchet connector.



These pictures show the temporary crown, immediately after surgery and then the healed site after 2 weeks.

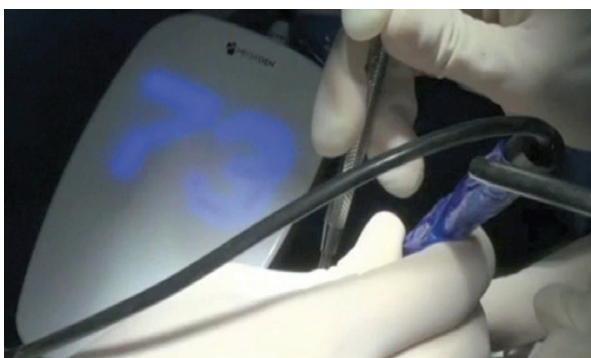

▲ The figures above can be applied only to an AnyRidge Implant. These figures cannot be generally applied to other implant systems.

In order to assess the possibility of immediate loading, we use both the placement torque and the ISQ value. Only when using the AnyRidge System, we may try immediate loading – and then only if the placement torque is over 45N and the ISQ value is over or equal to 70 in D3~D1 bone without parafunctional problems.



After time needed for soft tissue healing, the prosthesis can be made using an impression for final prosthesis taken at the customized abutment level.

After 4 months, this is the image of the final prosthesis loaded.

For the success of immediate loading,

1. Bone quality
2. Implant design
3. Surgical technique
4. Occlusal loading control should all be considered.

Next we will introduce you to how to use the 'Digital EYE™' to assess bone quality using R2GATE™ for surgical planning.

# *It guarantees a success of an implant through 'Digital EYE™' function even at the poor bone quality*

## 4. Clinical cases using an R2 Guide™ (2) - Dr. Jong-Cheol Kim

At the end of the last article, the necessary conditions for the success of immediate loading were briefly mentioned.

1. Bone quality
2. Implant design
3. Surgical technique
4. Occlusal loading control

Most long-term observational research mentions that the above four requirements affect the success of immediate loading. Utilizing CBCT as an assessment of bone quality is now being introduced in research papers. In evaluating bone quality R2GATE™ also uses a function that enables preoperative evaluation of bone quality and makes it possible to suggest a suitable drilling sequence to increase initial stability.

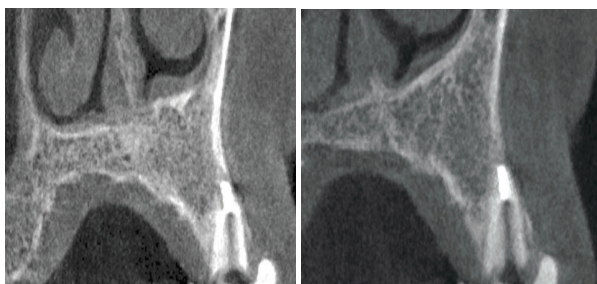

CT images shown on both the left and right are the same patient's CT image. Depending on the machine, as shown in the pictures, totally different images are created. CBCT is different to MSCT (Multi Slice CT) – it does not apply the HU (Hounsfield Unit) concept. This makes it more difficult to evaluate the bone quality.

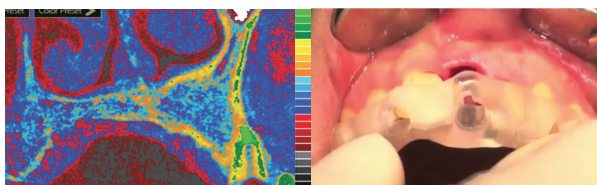

In order to resolve the disadvantages of CBCT, R2GATE™ has installed the 'Digital EYE™'. The colors shown on the image of the soft tissue helps to understand the bone quality thanks to the contrast of color. You may identify the relatively hard cortical bone density and the cancellous bone clearly falls under classification D4 according to Lekholm and Zarb's classification. Considering this bone quality, you might make 2 step under-drilling compared to the planned fixture diameter.

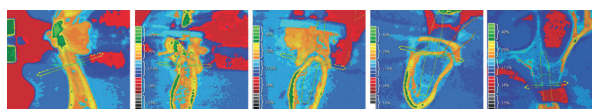

[ Ex. 1, 2, 3, 4, 5 ]

Correct drilling sequence, implant position, and loading protocol can be determined based on CT analysis. Take note though [Example 4, 5] even if initial stability can be gained by determining bone density, do you think immediate loading is always possible? What are your thoughts, readers?

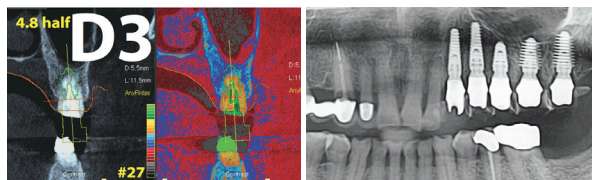
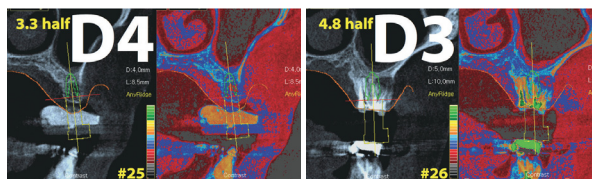
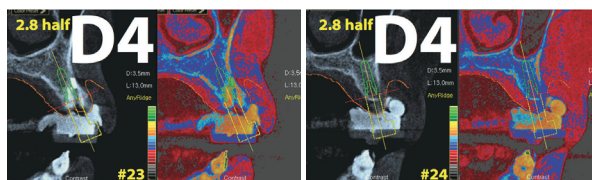

This clinical case used 'Digital EYE™', predicted the bone quality and pre-set the drilling sequence to obtain satisfactory initial stability, and also increased the number of implants for a 'One Day Implant' case. What the ISQ value would be at the time of surgery?

Edentulous clinical cases need restoration and we present another clinical trial. Do you think that a fixation screw is the only way to



## *R2 Guide™ is very effective for Full Mouth cases, even with thin ridge*

obtain stability of the stent when using an R2GATE Guide™ for edentulous cases? Tooth-supported guides have the highest precision. Currently, 'Team Eureka R2' is trying to develop a way to obtain 'Dual stability' by using the Palatal Denture Stabilizer.

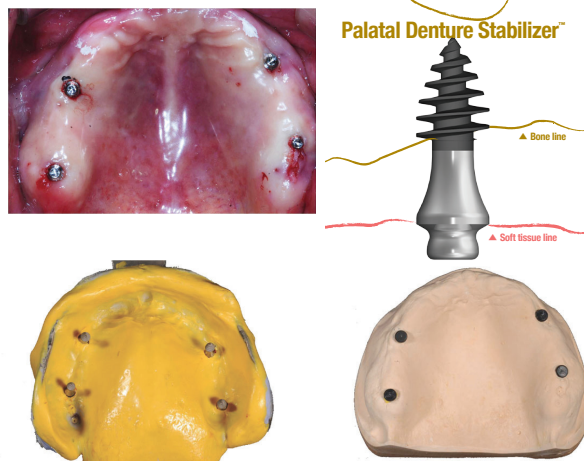

One way to change fully edentulous cases to a tooth-supported case would be placing mini implants. Mini implants were originally developed for the purpose of maintaining temporary dentures and they can be used on edentulous cases with R2 surgery. For the mini implant placement, the implant position is not important - simply place it where it can be placed most easily.



Two R2 Guide™s can be easily manufactured based on the basic CAD/CAM system. The first R2 Guide™ gets support from four mini implants. The method is to place fixtures on areas not related to the location where the mini implants will be placed. Then, a surgical stent will be used to place the fixtures and finally the mini fixtures are removed.

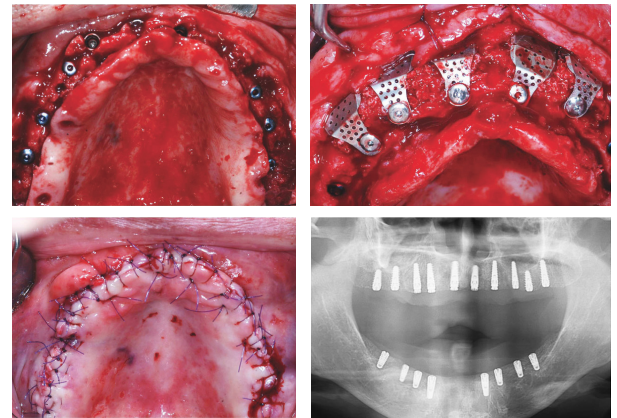

As mentioned in an earlier article, the author placed implants on the basis of the R2 Guide™, executed GBR, and made the closure suturing. Once again, the purpose and significance of R2 Guide™ surgery is not simply flapless surgery but to virtually manage & observe the result of surgery before the actual surgery following your own clinical philosophy.

'Megagen Eureka R2' started ambitiously with the intention of beginning a 2nd Renaissance in the field of implant treatment and recovery using our own program. The 'R2GATE' programme is evolving to realize this aim. Next year, we will be able to move beyond the implant field and provide new methods for GBR. In addition, we hope to achieve virtual surgery on the lower jaw using face analysis.

- Courtesy of Dr. Kwang-Bum Park, Dr. Seong-Eon Kim, Dr. Sang-Taek Lee.

\* This clinical case can be viewed on [www.R2GATE.com](http://www.R2GATE.com)  
'How to get a reliable ISQ value'

# FACEGIDE™

## All good up to analyses

R2GATE is an innovative implant diagnostic software that analyses the oral condition and shows the best options for implant treatment.

With FACEGIDE, we take one step further into maxillofacial surgery.

Using the same technology for accurate reading of the bone and tissue situation and with advanced software options, FaceGide opens the door to using **R2GATE®** for more predictable **Orthognathic surgery**.

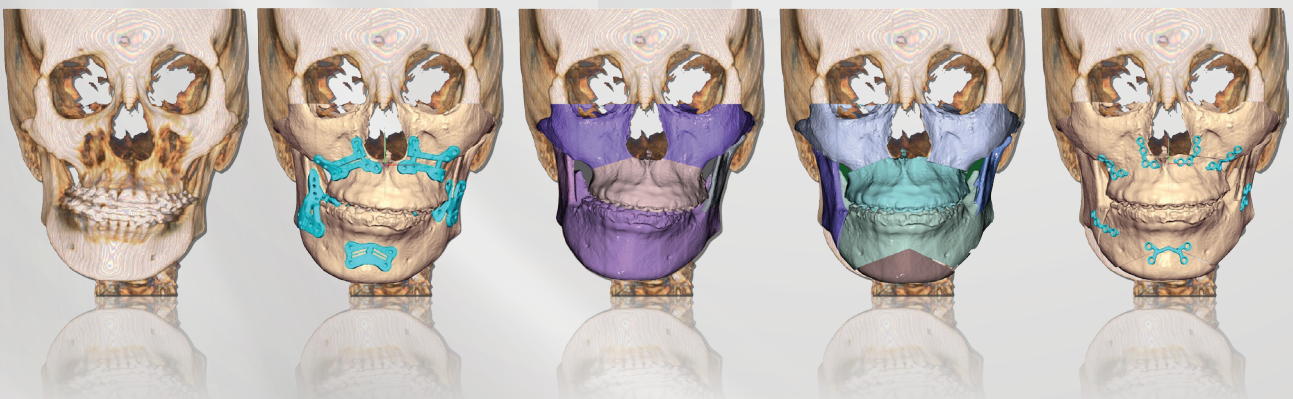

“How to use **R2GATE®** for **Orthognathic surgery?**”

**Safety and Minimal Invasiveness, Predictability**

**Efficiency, Patient-Oriented**

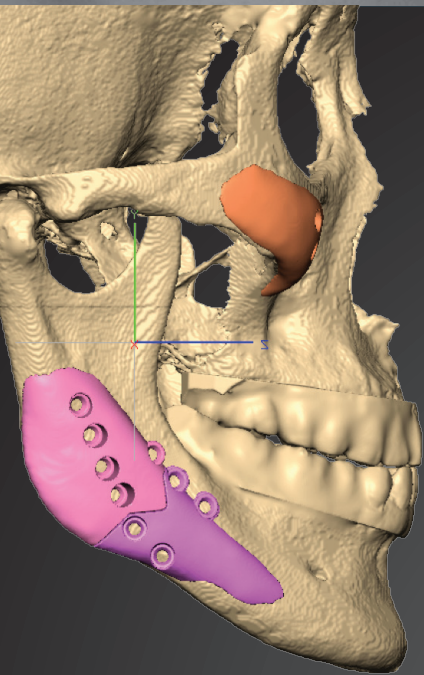
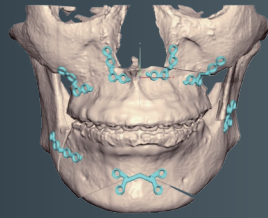
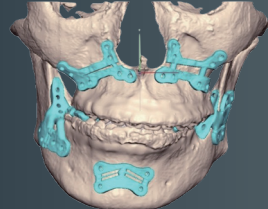
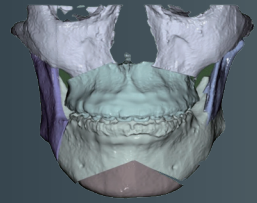

## FACEGIDE Reconstruction



# Full 3D Digital Solution!

- Exactly reproduces the results of digital diagnosis for surgery
- Guides and customized plates for predictable surgery
- Provides precise 3D simulation and intuitive data

### FACEGIDE Reconstruction™ Indications

- Wide-ranging restoration for mandibular bone loss (due to trauma or surgical failure)
- Chin reconstruction for micrognathia
- Restoration of mandible due to oral cancer or other lesions in the bone
- Provides support by replacing deficient areas in the orbital margin or orbital floor
- Replaces deficient zygomatic bone

### Scope of Application

- Mandibular bone deficiency, zygoma, orbital margin

### Shapes

- Stock screw grooves can be custom fabricated in various shapes to account for deficiencies

### Material

- Titanium Grade4

### FACEGIDE Reconstruction™ Scope of Use

- Wide ranging restoration of the mandible (mandible reconstruction, revision surgery)
- Wide ranging restoration of zygoma & orbital margin
- Cannot be used in load-bearing areas or joints (i.e., TMJ)

### One Time Use

- Unable to be reused as it is custom-fabricated for a specific patient. It is provided unsterilized (requires standard sterilization in a clinic).

## ✓ A Complete Digital Process from Diagnosis to Product Fabrication

This product is to diagnose patients using 3D simulation and to fabricate customized prostheses for a specific deficiency, dramatically increasing convenience and safety during surgery.

## ✓ Experts Specialized in 3D Analysis and Design

The FACEGIDE Team is composed of skilled 3D designers with more than 5 years of experience, providing simulations reflecting the characteristics and systems of each clinic and producing products after a real-time confirmation process.

## ✓ FACEGIDE, Verified and Currently Used in 12 University Hospitals in Korea

FACEGIDE is a verified product that has been used for more than 4 years for double jaw surgeries and mandibular reconstruction in 12 university hospitals including Seoul National University, Hallym University and Busan University.

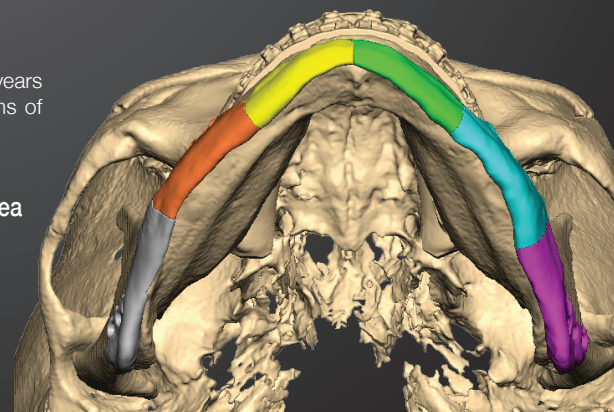



# R2 Surgical KIT

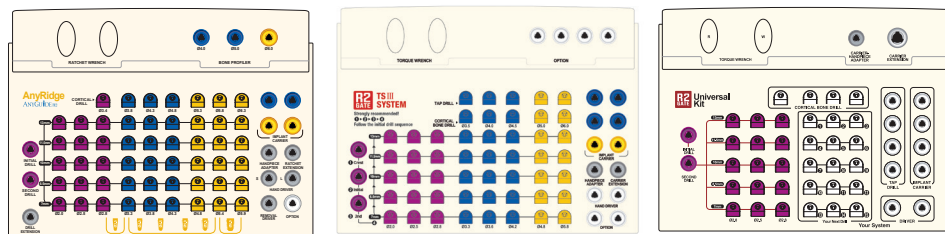

- 530 **R2 FULL Surgical KIT**
- 530 **I. AnyRidge System**
- 532 **II. BLUEDIAMOND IMPLANT System**
- 534 **III. AnyOne System**
  
- 542 **R2 Standard KIT**
- 542 **I. TSIII System (Osstem co.)**
- 544 **II. SuperLine System (Dentium co.)**
- 546 **III. UFII System (DIO co.)**
- 548 **IV. ISII System (Neo Biotech co.)**
  
- 556 **R2 Universal KIT**
- 560 **1. BLUEDIAMOND IMPLANT**
- 560 **2. Straumann**
- 562 **3. Nobel Biocare**
- 562 **4. Astra**
- 563 **5. Biomet 3i**
- 563 **6. TSIII**
- 563 **7. SuperLine**
- 564 **8. ISII**
- 564 **9. UFII**
  
- 566 **R2 Narrow KIT**
  
- 568 **R2 Anchor KIT**

# R2 Full Surgical KIT

## I. R2 Full Surgical Kit for AnyRidge System

- If you only use a specific system, corresponding system's full kit can be provided.
- R2 full surgical kit is composed with all of drills and components that are needed for the Digital Guided Surgery which uses R2 Guide™ after R2GATE diagnosis. It helps to actualize minimally invasive surgery and makes exact clinical result as the diagnosis.

Ref.C  
KAGIN3000



### Cortical Bone Drill

In type I or II bone, crestal bone is partly reduced to lower the pressure against the fixture during placement.

### Initial Drill

Initial Drill

Second Drill

Drilling to make the initial drill path

### AnyRidge ANYGUIDE R2

CORTICAL DRILL

	Ø3.4	Ø3.8	Ø4.3
13mm			
11.5mm			
10mm			
8.5mm			
7mm			
DRILL EXTENSION	Ø2.0	Ø2.5	Ø2.8
	Ø3.5	Ø4.0	Ø4.5

### Guide Stop Drill

Drill Diameter : Ø2.0 ~ Ø5.9  
Drill Length : 7.0 ~ 13.0mm

Guide Length : 13.5mm  
Drilling Length : 7.0 ~ 13.0mm

### Drill Extension

### Bone Profiler



This is used to minimize the interference of the crestal bone when connecting ZrGEN Abutment, [Used before placing the fixture / Recommended RPM 600 ~1000]

### Implant Carrier

- : Handpiece Type
- : Ratchet Type

► R – AnyRidge Regular (ø3.5 ~ ø4.5)



► W – AnyRidge Wide (ø5.0 ~ ø6.0)



Ø4.0    Ø5.0    Ø6.0

**BONE PROFILER**

Ø4.8    Ø5.3    Ø5.8    Ø6.3

**IMPLANT CARRIER**

**HANDPIECE ADAPTER**    **RATCHET EXTENSION**

**HAND DRIVER** (S, L)

**REMOVAL DRIVER**    **OPTION**

Ø4.3    Ø4.8    Ø5.4    Ø5.9

Ø5.0    Ø5.5    Ø6.0



### Hand Driver

- : 1.2 Hex Driver (Short)
- : 1.2 Hex Driver (Long)
- : Abutment Remover Driver



### Carrier-Handpiece Adapter



### Carrier Extension



# II. R2 Full Surgical Kit for BLUEDIAMOND IMPLANT System

- If you only use a specific system, corresponding system's full kit can be provided.
- R2 full surgical kit is composed with all of drills and components that are needed for the Digital Guided Surgery which uses R2 Guide™ after R2GATE diagnosis. It helps to actualize minimally invasive surgery and makes exact clinical result as the diagnosis.

Ref.C  
KAGIN3002

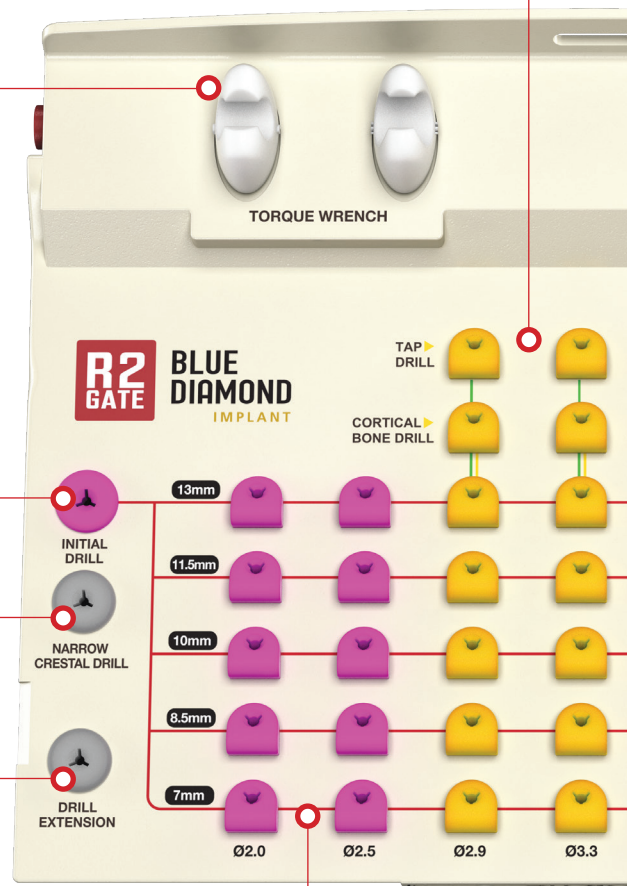

**Cortical Bone Drill**

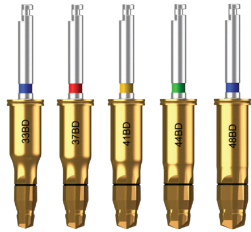

**Bone Profiler**



**Second Drill**

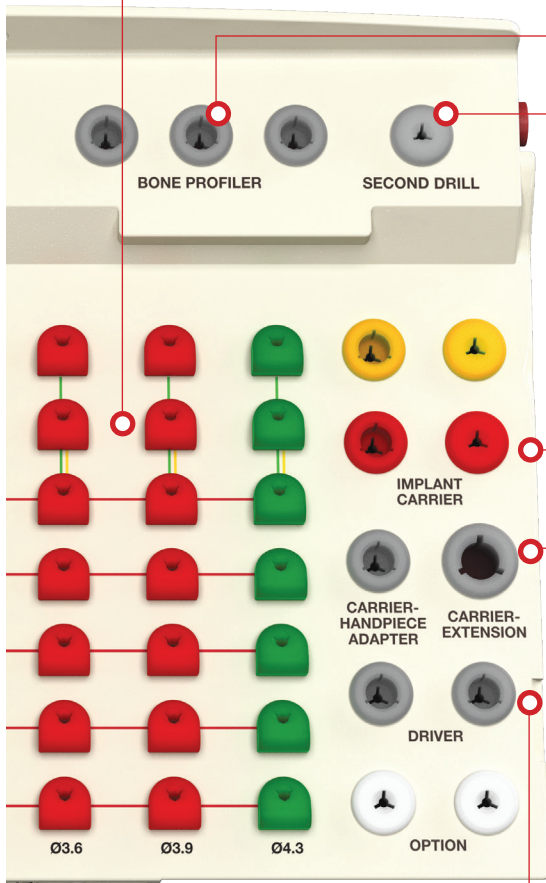

**Implant Carrier**

- : Handpiece Type
- : Ratchet Type

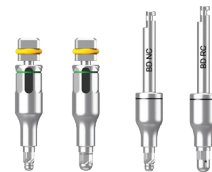

**Hand Driver**



**Carrier-Handpiece Adapter**



**Carrier Extension**



# III. R2 Full Surgical Kit for AnyOne System

- If you only use a specific system, corresponding system's full kit can be provided.
- R2 full surgical kit is composed with all of drills and components that are needed for the Digital Guided Surgery which uses R2 Guide™ after R2GATE diagnosis. It helps to actualize minimally invasive surgery and makes exact clinical result as the diagnosis.

Ref.C  
KAGIN3001



### Initial Drill

Initial Drill

Second Drill

Drilling to make the initial drill path

### Cortical Bone Drill

In type I or II bone, crestal bone is partly reduced to lower the pressure against the fixture during placement.

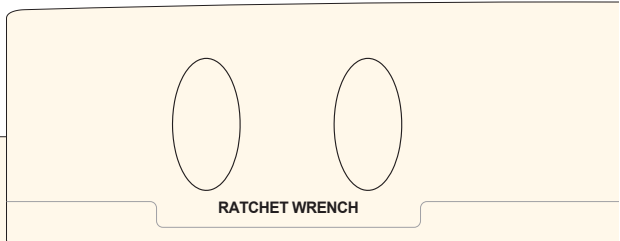

### AnyOne ANYGUIDE R2

**CORTICAL DRILL**

Ø3.5    Ø4.0

13mm

11.5mm

10mm

8.5mm

7mm

**INITIAL DRILL**

**SECOND DRILL**

Ø2.0    Ø2.5    Ø2.8    Ø3.3    Ø3.6

**DRILL EXTENSION**

Ø3.5    Ø4.0

### Guide Stop Drill

Drill diameter : Ø2.0 ~ Ø 5.9  
Drill Length : 7.0 ~ 13.0mm

Guide length : 13.5mm  
Drilling length : 7.0 ~ 13.0mm

### Drill Extension

### Bone Profiler



This is used to minimize the interference of the crestal bone when connecting ZrGEN Abutment. [Used before placing the fixture / Recommended RPM 600 ~1000]

### Implant Carrier

: Handpiece Type  
: Ratchet Type

► R – AnyOne Regular (ø3.5 ~ø4.5)

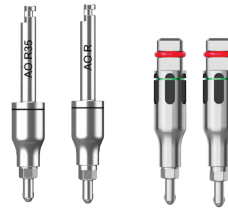

► W – AnyOne Wide (ø5.0 ~ ø6.0)

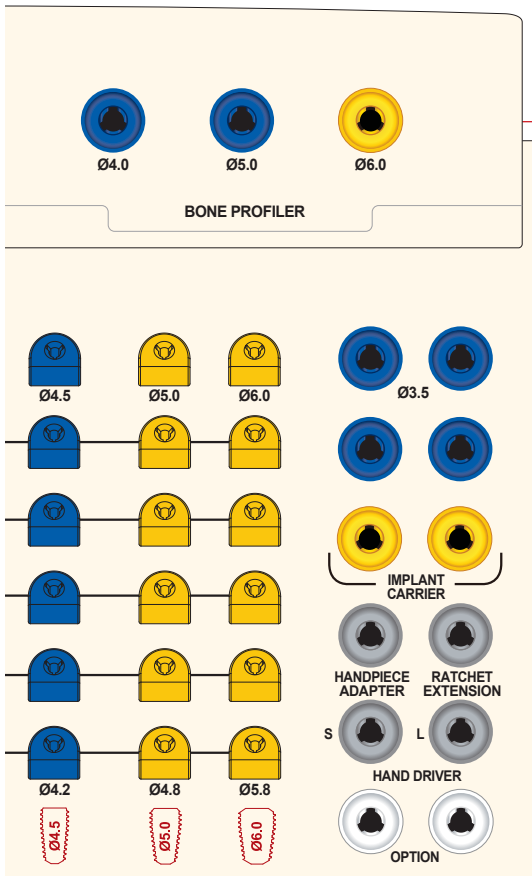
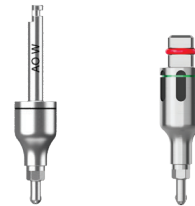

### Hand Driver : 1.2 Hex Driver (Short/Long)



### Carrier-Handpiece Adapter



### Carrier Extension



## ➔ Components for R2 Full Surgical Kit (Continued)

- If you only use a specific system, corresponding system's full kit can be provided.
- R2 full surgical kit is composed with all of drills and components that are needed for the Digital Guided Surgery which uses R2 Guide™ after R2GATE® diagnosis. It helps to actualize minimally invasive surgery and makes exact clinical result as the diagnosis.

### Initial Drill

- Use the initial drill in order to mark the drilling position on the bone. Start drilling slowly, when drill guide part is fully contacted with drilling core of R2 Guide™.
- Recommended drilling speed range is 300 ~ 800 RPM with copious irrigation.

Diameter	Guide Diameter	Length(mm)	Ref.C
Ø2.6	Ø5.0	1.0	R2ID2601

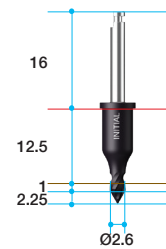

### Second Drill

- This unique step-drill(from Ø2.0 to Ø4.6) is used to flare out the upper cortical bone of the osteotomy.
- It helps not only the rest drilling procedure but abut- ment connection. In case of hard bone, if the 2nd drilling will be disturbed by thick cortical bone. Stop the drilling and try it after final drilling procedure.

Diameter	Guide Diameter	Length(mm)	Ref.C
Ø2.5	Ø5.0	5.0	R2SD2505

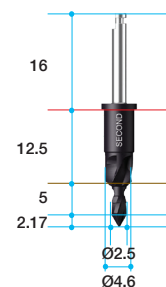

### Stopper Drill

- Universal drills consist of Ø2.0, Ø2.5, Ø2.8 diameter to enlarge the osteotomy gradually.
- The length of drill are designed as 7.0, 8.5, 10, 11.5, 13mm for most common length of implant system.
- Recommended drilling speed range is 500 ~ 800 RPM with copious irrigation.

Diameter	Guide Diameter	Length(mm)	Ref.C
Ø2.0	Ø3.5	6.5	AGSD2007
		8.0	AGSD2008
		9.5	AGSD2010
		11.0	AGSD2011
		12.5	AGSD2013
Ø2.5	Ø3.5	6.5	AGSD2507
		8.0	AGSD2508
		9.5	AGSD2510
		11.0	AGSD2511
Ø2.8	Ø3.5	12.5	AGSD2513
		6.5	AGSD2807
		8.0	AGSD2808
		9.5	AGSD2810
		11.0	AGSD2811
		12.5	AGSD2813

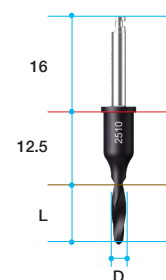

### Bone Profiler

- Recommended drilling speed is 300 ~ 800 RPM.

Diameter	Guide Diameter	Ref.C
Ø4.0	Ø5.0	AGBP40
Ø5.0		AGBP50
Ø6.0	Ø6.5	AGBP60



### Stopper Drill [AR]

• Recommended drilling speed is 300 ~ 800 RPM.

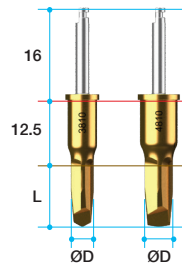

Diameter	Guide Diameter	Length(mm)	Ref.C
Ø3.3	Ø5.0	6.5	ARSD3307
		8.0	ARSD3308
		9.5	ARSD3310
		11.0	ARSD3311
		12.5	ARSD3313
Ø3.8	Ø5.0	6.5	ARSD3807
		8.0	ARSD3808
		9.5	ARSD3810
		11.0	ARSD3811
		12.5	ARSD3813
Ø4.3	Ø5.0	6.5	ARSD4307
		8.0	ARSD4308
		9.5	ARSD4310
		11.0	ARSD4311
		12.5	ARSD4313

Diameter	Guide Diameter	Length(mm)	Ref.C
Ø4.8	Ø6.5	6.5	ARSD4807
		8.0	ARSD4808
		9.5	ARSD4810
		11.0	ARSD4811
		12.5	ARSD4813
Ø5.4	Ø6.5	6.5	ARSD5407
		8.0	ARSD5408
		9.5	ARSD5410
		11.0	ARSD5411
		12.5	ARSD5413
Ø5.9	Ø6.5	6.5	ARSD5907
		8.0	ARSD5908
		9.5	ARSD5910
		11.0	ARSD5911
		12.5	ARSD5913

### Stopper Drill [BD]

- Diameters: Ø2.0, Ø2.5, Ø2.8 for gradual enlargement of osteotomy
- Drill lengths: 7.0, 8.5, 10, 11.5, 13mm appropriate for most implant lengths
- Recommended drilling speed: 500 ~ 800 RPM with copious irrigation.

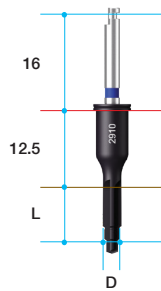

Diameter	Guide Diameter	Length(mm)	Ref.C
Ø2.0	Ø5.0	6.5	R2SD2007
		8	R2SD2008
		9.5	R2SD2010
		11	R2SD2011
		12.5	R2SD2013
Ø2.5	Ø5.0	6.5	R2SD2507
		8	R2SD2508
		9.5	R2SD2510
		11	R2SD2511
		12.5	R2SD2513
Ø2.9	Ø5.0	7	R2UD2907
		8	R2UD2908
		9.5	R2UD2910
		11	R2UD2911
		12.5	R2UD2913
Ø3.3	Ø5.0	7	R2UD3307
		8	R2UD3308
		9.5	R2UD3310
		11	R2UD3311
		12.5	R2UD3313

Diameter	Guide Diameter	Length(mm)	Ref.C
Ø3.6	Ø5.0	7	R2UD3607
		8	R2UD3608
		9.5	R2UD3610
		11	R2UD3611
		12.5	R2UD3613
Ø3.9	Ø5.0	7	R2UD3907
		8	R2UD3908
		9.5	R2UD3910
		11	R2UD3911
		12.5	R2UD3913
Ø4.3	Ø5.0	7	R2UD4307
		8	R2UD4308
		9.5	R2UD4310
		11	R2UD4311
		12.5	R2UD4313

## ➔ Components for R2 Full Surgical Kit (Continued)

### Stopper Drill[AO]

• Recommended drilling speed is 300 ~ 800 RPM.



Diameter	Guide Diameter	Length(mm)	Ref.C	Diameter	Guide Diameter	Length(mm)	Ref.C
Ø3.3	Ø5.0	7.0	AOSD3307	Ø4.8	Ø6.5	7.0	AOSD4807
		8.0	AOSD3308			8.0	AOSD4808
		9.5.0	AOSD3310			9.5	AOSD4810
		11.0	AOSD3311			11.0	AOSD4811
		12.5	AOSD3313			12.5	AOSD4813
Ø3.6	Ø5.0	7.0	AOSD3607	Ø5.8	Ø6.5	7.0	AOSD5807
		8.0	AOSD3608			8.0	AOSD5808
		9.5	AOSD3610			9.5	AOSD5810
		11.0	AOSD3611			11.0	AOSD5811
Ø4.2	Ø5.0	12.5	AOSD3613	Ø6.5	Ø6.5	12.5	AOSD5813
		7.0	AOSD4207				
		8.0	AOSD4208				
		9.5	AOSD4210				
		11.0	AOSD4211				
		12.5	AOSD4213				

### Cortical Bone Drill [AR]

• Recommended drilling speed : 300 ~ 800 RPM

Diameter	Guide Diameter	Length(mm)	Ref.C
Ø3.4	Ø5.0	5.0	R2CD3405
Ø3.8			R2CD3805
Ø4.3			R2CD4305
Ø4.8			R2CD4805
Ø5.3	Ø6.5	5.0	R2CD5305
Ø5.8			R2CD5805
Ø6.3			R2CD6305

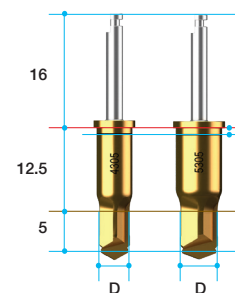

### Cortical Bone Drill [BD]

• Recommended drilling speed : 300 ~ 800 RPM

Diameter	Guide Diameter	Length(mm)	Ref.C
Ø3.6	Ø5.0	6.5	R2BDCD33
Ø4.0			R2BDCD37
Ø4.4			R2BDCD41
Ø4.7			R2BDCD44
Ø4.95			R2BDCD48

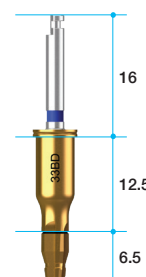

## Cortical Bone Drill [AO]

- Recommended drilling speed : 300 ~ 800 RPM

Diameter	Guide Diameter	Length(mm)	Ref.C
Ø3.9	Ø5.0	6.0	AODD39
Ø4.3			AODD43
Ø4.8			AODD48
Ø5.3	Ø6.5	5.5	AODD53
Ø6.3			AODD63

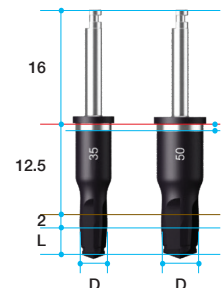

## Tap Drill [BD]

- For insertion test before placing fixture
- To avoid enlarging osteotomy, select tap drill one-size smaller than osteotomy
- Recommended insertion torque & speed: 45 ~ 50Ncm, under 40 RPM.

Diameter	Guide Diameter	Length(mm)	Ref.C
Ø3.6	Ø5.0	9.5	R2TD33ARO
Ø4.0			R2TD37ARO
Ø4.4			R2TD41ARO
Ø4.7			R2TD44ARO
Ø5.0			R2TD48ARO
			R2TD48ARO

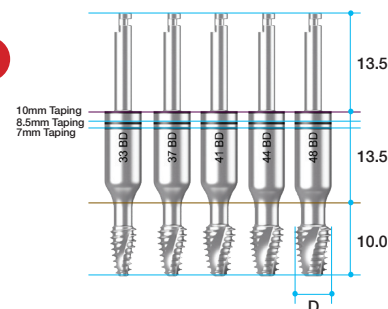

## Implant Carrier[AR]

- The purpose of tap drills in the universal kit system is insertion test. some of implant are required this procedure before final fixture insertion. choose the one-step under size of tab to protect from enlargement of osteotomy.
- Recommended insertion torque and speed is 45 ~ 50Ncm, under 40 RPM.

Connection	Guide Diameter	Type	Ref.C
2.3 Hex	Ø5.0	Ratchet	ICRH2324
			ICWH2324
	Ø6.5	Handpiece	ICRH2324H
			ICWH2324H

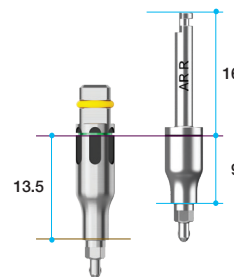

## Implant Carrier[AR]

- The purpose of tap drills in the universal kit system is insertion test. some of implant are required this procedure before final fixture insertion. choose the one-step under size of tab to protect from enlargement of osteotomy.
- Recommended insertion torque and speed is 45 ~ 50Ncm, under 40 RPM.

Connection	Guide Diameter	Type	Ref.C
2.1 Octa	Ø5.0	Ratchet	ICRO2127
2.5 Octa			ICRO2530
2.1 Octa	Ø5.0	Handpiece	ICRO2127H
2.5 Octa			ICRO2530H

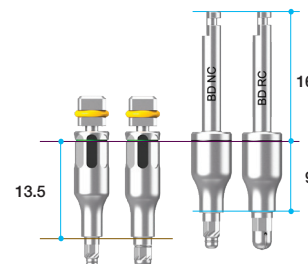

## Implant Carrier[AO]

- Two different implant carriers for regular stent since Ø3.5 fixture has different abut- ment connection
- To pick up the fixture from the ampule and insert it to the osseotomy. Then turn it to clock-wise direction 2~3 times manually.
- When it gets fixation from the osteotomy, connect the handpiece adaptor and use implant motor.
- Recommended insertion torque is 45~50Ncm.

Connection	Guide Diameter	Type	Ref.C
2.5 Hex	Ø5.0	Ratchet	ICRH2518
			ICRH2523
	Ø6.5	Handpiece	ICWH2523
			ICWH2523H

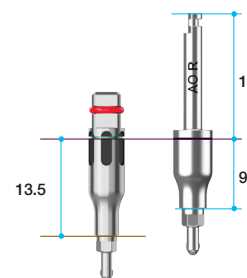

## ➔ Components for R2 Full Surgical Kit (Continued)

### Carrier-Handpiece Adapter

- Useful to use the handpiece for the implant placement following initial delivery of a fixture with a fixture carrier.

Diameter	Ref.C
5.0	AGHA



### Carrier Extension

- To extend the length of implant carrier.

Diameter	Ref.C
4.0	MRE400S



### Drill Extension

- No more than 35Ncm torque : May distorted when excessive force is applied.
- Extends drills & other handpiece instruments.

Ref.C
MDE150



### Hand Driver (1.2 Hex)

- Used for all Cover Screws, Abutment Screws, and Healing Abutments.
- Available in 4 lengths for added convenience.
- Hand Driver can be directly inserted into the Torque Wrench without using an adaptor.
- Hex tip can with stand 35-45Ncm of torque without distorting.

Length(mm)	Type	Ref.C
5.0	*Ultra-short	TCMHDU1200
10	Short	TCMHDS1200
15	Long	TCMHDL1200
20	*Extra-long	TCMHDE1200



(\* Separate sales item.

### Ratchet Wrench

- Used to exert more force than the Handpiece.
- No bearing system : No breakage and no corrosion problems.
- Arrow laser marking indicates direction of force.

Ref.C
MRW040S



### Torque Wrench [BD] (Ratchet type)

- Use for implant placement & final tightening of abutment screw

Type	Ref.C
Torque Wrench	TWSQ70

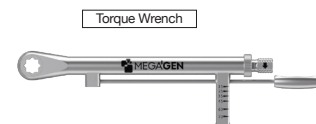

### Torque Wrench & Adapter

- Use for implant placement & final tightening of abutment screw
- Torque range: 15Ncm to 45Ncm

Type	Ref.C
*Torque Wrench	MTW300A
**Torque Wrench Adapter (Handpiece)	TTAI100
*Torque Wrench Adapter (Ratchet)	TTAR100

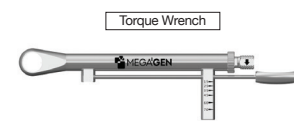

Torque Wrench Adapter



Handpiece Ratchet

(\* Separate sales item.

## Narrow Crest Drill

- Use for angled fixture placement or to flatten bone surface of narrow ridge to prevent slipping during drilling
- Use to harvest autogenous bone if used after soft tissue
- 2-piece design: drill body & housing
- Disassemble to remove bone chips & for easy cleaning

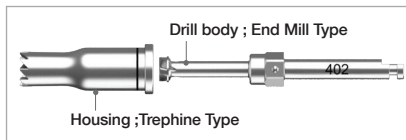

Diameter	Guide Diameter	Length(mm)	Ref.C
Ø4.0	Ø5.0	15.5(12.5/2)	NCD402

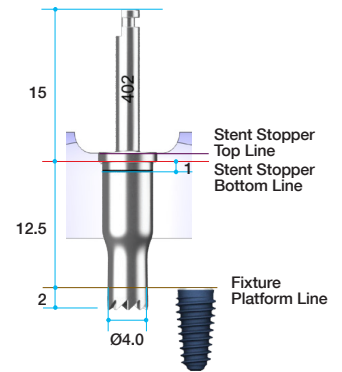

## ➔ System Options for the AnyOne External

### Cortical Bone Drill

- Recommended drilling speed: 300-800 rpm

Diameter	Guide Diameter	Length(mm)	Ref.C
Ø3.9	Ø5.0	6.0	AODD39
Ø4.3			AODD43
Ø4.8			AODD48
Ø5.3	Ø6.5	5.5	AODD53
Ø6.3			AODD63

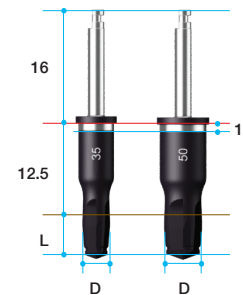

### Tap Drill

- The purpose of tap drills in the R2 Universal kit system is insertion test. some of implant are required this procedure before final fixture insertion. choose the one-step under size of tap to protect from enlargement of osteotomy.
- Recommended insertion torque and speed is 45 ~50Ncm, under 40 RPM.

Diameter	Guide Diameter	Length(mm)	Ref.C
Ø3.9	Ø5.0	9.5	R2TD35AO
Ø4.3			R2TD40AO
Ø4.8			R2TD45AO
Ø5.3	Ø6.5	9.5	R2TD50AO
Ø6.3			R2TD60AO

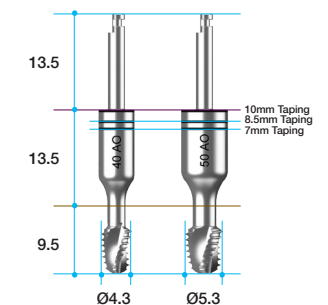

### Implant Carrier

- To pick up the fixture from the ampule and insert it to the osteotomy. Then turn it to clock-wise direction 2-3 times manually.
- When it gets fixation from the osteotomy, connect the handpiece adaptor and use implant motor
- Recommended insertion torque is 45-50Ncm.

Diameter	Guide Diameter	Type	Ref.C
2.5 Hex	Ø5.0	Ratchet	ICRAOE
	Ø6.5		ICWAOE

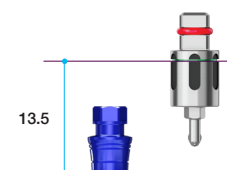

# R2 Standard KIT

## I. R2 Standard Kit for TSIII System (Osstem co.)

- If you only use a specific system, corresponding system's full kit can be provided.
- R2 full surgical kit is composed with all of drills and components that are needed for the Digital Guided Surgery which uses R2 Guide™ after R2GATE diagnosis. It helps to actualize minimally invasive surgery and makes exact clinical result as the diagnosis.

Ref.C

KAGTS3000



### Cortical Bone Drill

In type I or II bone, crestal bone is partly reduced to lower the pressure against the fixture during placement.

### Initial Drill

Initial Drill      Second Drill

Drilling to make the initial drill path

### R2 TS III SYSTEM

Strongly recommended!  
**1 ▶ 2 ▶ 3 ▶ 4**  
 Follow the initial drill sequence

TAP DRILL ▶

CORTICAL BONE DRILL ▶ Ø3.5      Ø4.0

### Guide Stop Drill

Drill Diameter : Ø2.0 ~ Ø 5.9  
 Drill Length : 7.0 ~ 13.0mm

Guide Length : 13.5mm  
 Drilling Length : 7.0 ~ 13.0mm

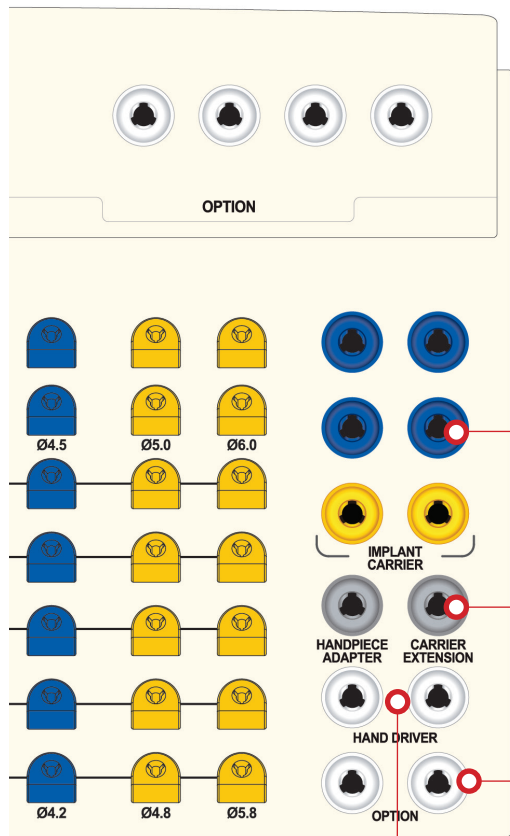

**Implant Carrier**

- : Handpiece Type
- : Ratchet Type

- ▶ R3.5 – Osstem MiniNi

- ▶ R3.5 – Osstem Regular

**Drill Extension**



**Hand Driver** : 1.2 Hex Driver (Short/Long)

**Carrier-Handpiece Adapter**

**Carrier Extension**

# II. R2 Standard Kit for SuperLine System (Dentium co.)

- If you only use a specific system, corresponding system's full kit can be provided.
- R2 full surgical kit is composed with all of drills and components that are needed for the Digital Guided Surgery which uses R2 Guide™ after R2GATE diagnosis. It helps to actualize minimally invasive surgery and makes exact clinical result as the diagnosis.

Ref.C  
KAGSL3000



### Initial Drill

Initial Drill



Second Drill



Drilling to make the initial drill path

### Cortical Bone Drill



In type I or II bone, crestal bone is partly reduced to lower the pressure against the fixture during placement.

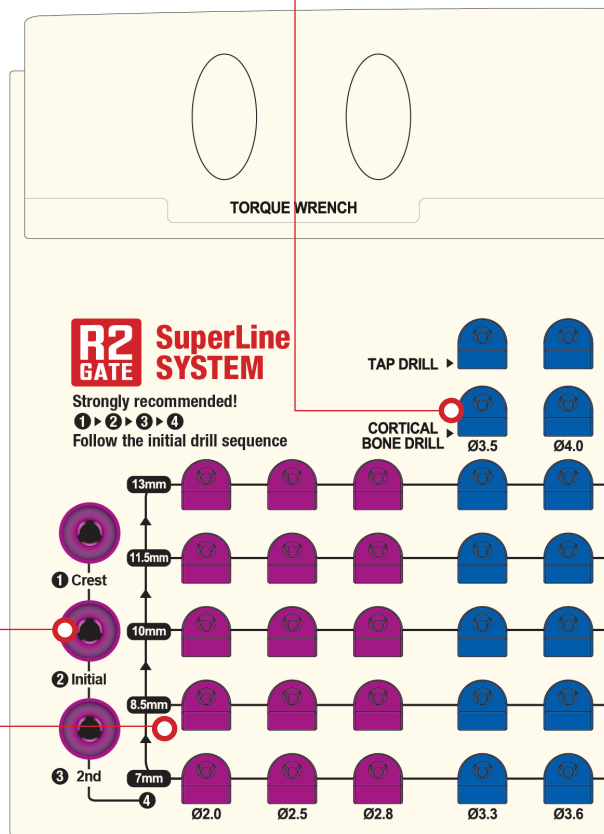

### Guide Stop Drill

Drill Diameter : Ø2.0 ~ Ø 5.9  
Drill Length : 7.0 ~ 13.0mm



Guide Length : 13.5mm  
Drilling Length : 7.0 ~ 13.0mm

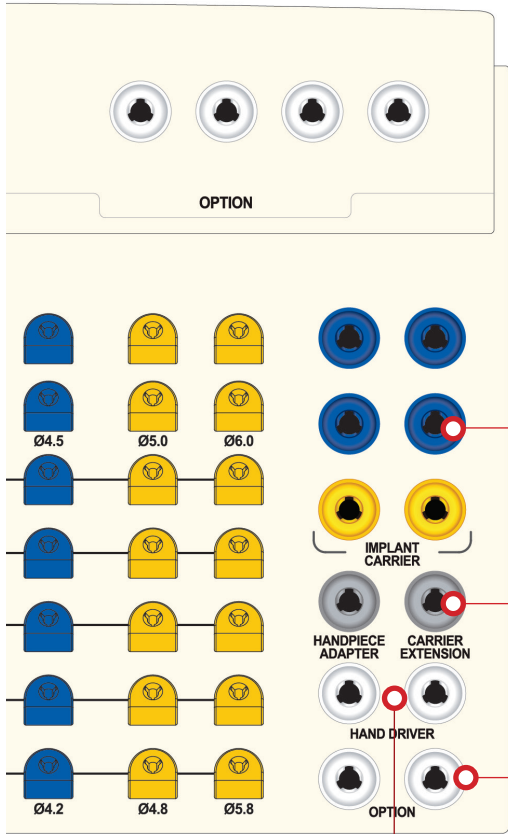

**Implant Carrier**  
: Ratchet Type

- ▶ R – Dentium Super Line (ø3.7 ~ ø4.5)
- ▶ W – Dentium Super Line Wide (ø5.0 ~ ø6.0)

**Drill Extension**



**Hand Driver** : 1.2 Hex Driver (Short/Long)

**Carrier-Handpiece Adapter**

**Carrier Extension**

# III. R2 Standard Kit for UFII System (DIO co.)

- If you only use a specific system, corresponding system's full kit can be provided.
- R2 full surgical kit is composed with all of drills and components that are needed for the Digital Guided Surgery which uses R2 Guide™ after R2GATE diagnosis. It helps to actualize minimally invasive surgery and makes exact clinical result as the diagnosis.

Ref.C  
KAGUF3000



### Initial Drill

Initial Drill

Second Drill

Drilling to make the initial drill path

### Cortical Bone Drill

In type I or II bone, crestal bone is partly reduced to lower the pressure against the fixture during placement.

### R2 GATE UF II SYSTEM

Strongly recommended!  
① ▶ ② ▶ ③ ▶ ④  
Follow the initial drill sequence

TAP DRILL ▶

CORTICAL BONE DRILL ▶

Ø3.5    Ø4.0

### Guide Stop Drill

Drill Diameter : Ø2.0 ~ Ø 5.9  
Drill Length : 7.0 ~ 13.0mm

Guide Length : 13.5mm

Drilling Length : 7.0 ~ 13.0mm

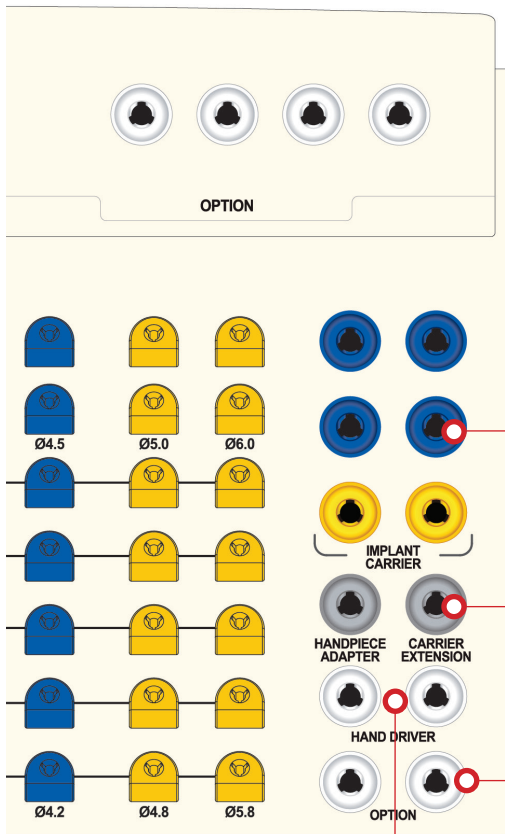

**Implant Carrier**

: Ratchet Type

- ▶ R-DIO UF II Regular (Ø3.7 ~ Ø4.5)
- ▶ W-DIO UF II WIDE (Ø5.0 ~ Ø5.5)

**Drill Extension**



**Hand Driver** : 1.2 Hex Driver (Short/Long)

**Carrier-Handpiece Adapter**

**Carrier Extension**

# IV. R2 Standard Kit for ISII System (Neo Biotech co.)

- If you only use a specific system, corresponding system's full kit can be provided.
- R2 full surgical kit is composed with all of drills and components that are needed for the Digital Guided Surgery which uses R2 Guide™ after R2GATE diagnosis. It helps to actualize minimally invasive surgery and makes exact clinical result as the diagnosis.

Ref.C  
KAGIS3000



### Initial Drill

Initial Drill

Second Drill

Drilling to make the initial drill path

### Cortical Bone Drill

In type I or II bone, crestal bone is partly reduced to lower the pressure against the fixture during placement.

### R2 GATE ISII SYSTEM

Strongly recommended!  
①▶②▶③▶④  
Follow the initial drill sequence

1 Crest

2 Initial

3 2nd

4

TAP DRILL ▶

CORTICAL BONE DRILL ▶

Ø3.5    Ø4.0

Ø2.0    Ø2.5    Ø2.8    Ø3.3    Ø3.6

### Guide Stop Drill

Drill Diameter : Ø2.0 ~ Ø 5.9  
Drill Length : 7.0 ~ 13.0mm

Guide Length : 13.5mm

Drilling Length : 7.0 ~ 13.0mm

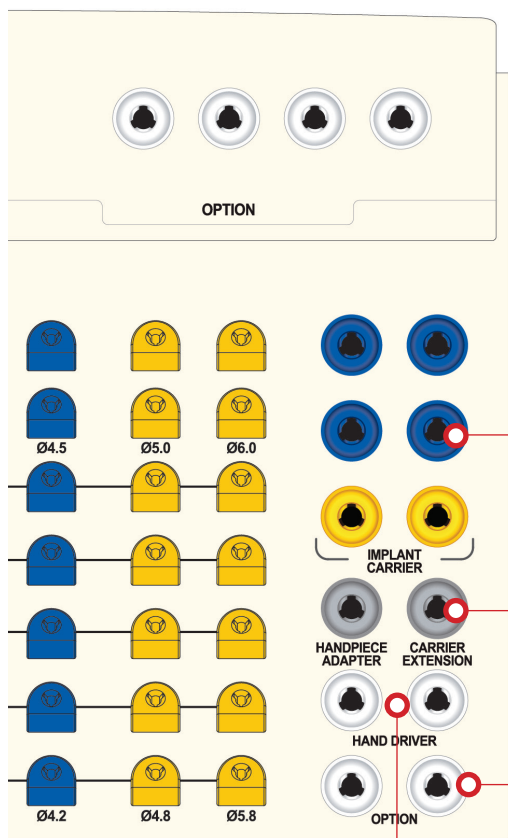

**Implant Carrier**

: Ratchet Type

- ▶ R-NEO IS II Regular (ø3.5 ~ ø4.5)
- ▶ W-NEO IS II WIDE (ø5.0)

**Drill Extension**



**Hand Driver** : 1.2 Hex Driver (Short/Long)

**Carrier-Handpiece Adapter**

**Carrier Extension**

## ➔ Components for R2 Standard Kit (Continued)

- If you use only a specific system, corresponding system's full kit can be provided.
- R2 full surgical kit is composed with all of drills and components that are needed for the Digital Guided Surgery which uses R2 GUIDE™ after R2GATE® diagnosis. It helps to actualize minimally invasive surgery and makes exact clinical result as the diagnosis.

### Initial Drill

- Use the initial drill in order to mark the drilling position on the bone. Start drilling slowly, when drill guide part is fully contacted with drilling core of R2 Guide™.
- Recommended drilling speed range is 300 ~ 800 RPM with copious irrigation.

Diameter	Guide Diameter	Length(mm)	Ref.C
Ø2.6	Ø5.0	1.0	R2ID2601

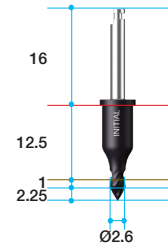

### Second Drill

- This unique step-drill(from Ø2.0 to Ø4.6) is used to flare out the upper cortical bone of the osteotomy.
- It helps not only the rest drilling procedure but abutment connection. In case of hard bone, if the 2nd drilling will be disturbed by thick cortical bone. Stop the drilling and try it after final drilling procedure.

Diameter	Guide Diameter	Length(mm)	Ref.C
Ø2.5	Ø5.0	5.0	R2SD2505

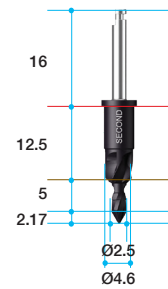

### Stopper Drill

- Universal drills consist of Ø2.0, Ø2.5, Ø2.8 diameter to enlarge the osteotomy gradually.
- The length of drill are designed as 7.0, 8.5, 10, 11.5, 13mm for most common length of implant system.
- Recommended drilling speed range is 500 ~ 800 RPM with copious irrigation.



Diameter	Guide Diameter	Length(mm)	Ref.C
Ø2.0	Ø5.0	6.5	R2SD2007
		8.0	R2SD2008
		9.5	R2SD2010
		11.0	R2SD2011
		12.5	R2SD2013
Ø2.5	Ø5.0	6.5	R2SD2507
		8.0	R2SD2508
		9.5	R2SD2510
		11.0	R2SD2511
		12.5	R2SD2513
Ø2.8	Ø5.0	6.5	R2SD2807
		8.0	R2SD2808
		9.5	R2SD2810
		11.0	R2SD2811
		12.5	R2SD2813
Ø3.3	Ø5.0	7.0	AOSD3307
		8.0	AOSD3308
		9.5	AOSD3310
		11.0	AOSD3311
		12.5	AOSD3313
Ø3.6	Ø5.0	7.0	AOSD3607
		8.0	AOSD3608
		9.5	AOSD3610
		11.0	AOSD3611
		12.5	AOSD3613
Ø4.2	Ø5.0	7.0	AOSD4207
		8.0	AOSD4208
		9.5	AOSD4210
		11.0	AOSD4211
		12.5	AOSD4213

Diameter	Guide Diameter	Length(mm)	Ref.C
Ø4.8	Ø6.5	7.0	AOSD4807
		8.0	AOSD4808
		9.5	AOSD4810
		11.0	AOSD4811
Ø5.8	Ø6.5	12.5	AOSD4813
		7.0	AOSD5807
		8.0	AOSD5808
		9.5	AOSD5810
		11.0	AOSD5811
		12.5	AOSD5813

## Cortical Bone Drill

- Recommended drilling speed : 300 ~ 800 RPM

Diameter	Guide Diameter	Length(mm)	Ref.C
Ø3.4	Ø5.0	5.0	R2CD3405
Ø3.8			R2CD3805
Ø4.3			R2CD4305
Ø4.8			R2CD4805
Ø5.3	Ø6.5		R2CD5305
Ø5.8			R2CD5805
Ø6.3			R2CD6305
			R2CD6305

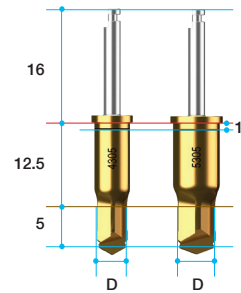

## Carrier-Handpiece Adapter

- Useful to use the handpiece for the implant placement following initial delivery of a fixture with a fixture carrier.

Diameter	Ref.C
5.0	AGHA



## Ratchet Wrench

- Used to exert more force than the Handpiece.
- No bearing system : No breakage and no corrosion problems.
- Arrow laser marking indicates direction of force.

Ref.C
MRW040S



## ➔ Components for R2 Standard Kit

### Carrier Extension

- To extend the length of implant carrier.

Diameter	Ref.C
4.0	MRE400S



### Drill Extension

- No more than 35Ncm torque : May distorted when excessive force is applied.
- Extends drills & other handpiece instruments.

Ref.C
MDE150



### Hand Driver (1.2 Hex)

- Used for all Cover Screws, Abutment Screws, and Healing Abutments.
- Available in 4 lengths for added convenience.
- Hand Driver can be directly inserted into the Torque Wrench without using an adaptor.
- Hex tip can with stand 35-45Ncm of torque without distorting.

Length(mm)	Type	Ref.C
5.0	*Ultra-short	TCMHDU1200
10	Short	TCMHDS1200
15	Long	TCMHDL1200
20	*Extra-long	TCMHDE1200

(\*) Separate sales item.



## Narrow Crest Drill

- It is used when fixture will be slantly implanted or to flat the sloped bone surface of narrow ridge to prevent any slips during drilling.
- Design as 2-piece: drill body and housing
- Can be disassemble. Easy to clean and remove bone chips
- Can harvest autogenous bone if it is used after soft tissue

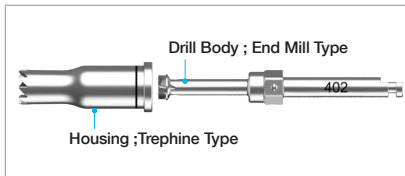

Diameter	Guide Diameter	Length(mm)	Ref.C
Ø4.0	Ø5.0	15.5(12.5/2)	NCD402

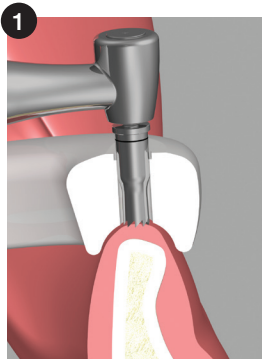
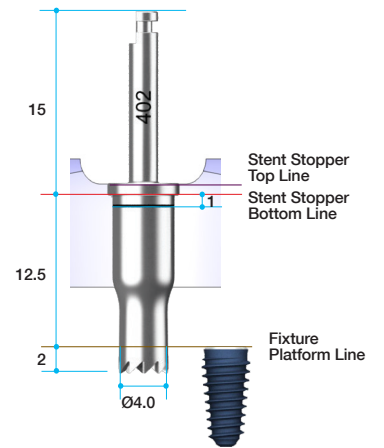

1 Set the site by drilling counter-clockwise with low speed ( $\leq 100\text{rpm}$ )

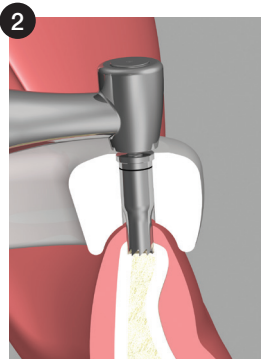

2 Start drilling clockwise (400~600rpm)

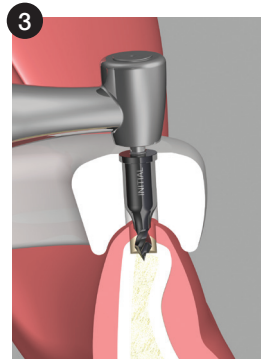

3 Bone is now flat. Perform drilling with proper drilling sequence.

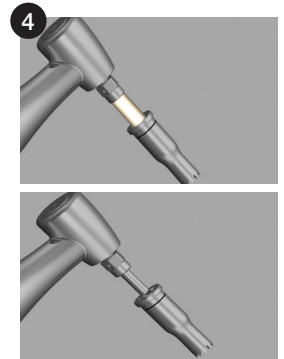

4 Disassemble body and housing after drilling to remove bone chip. Clean and sterilize after every usage.

## ➔ Components for R2 TSIII Standard Kit

### Implant Carrier

- Two different implant carriers for regular guide since Ø3.5 fixture has different abutment connection- ICRH2127 : Ø3.5 fixture- ICRH2523O : Ø4.0, Ø4.5 fixture
- To pick up the fixture from the ampule and insert it to the osseotomy. Then turn it to clock-wise direction 2~3 times manually.
- When it gets fixation from the osteotomy, connect the handpiece adaptor and use implant motor.
- Recommended insertion torque is 45~50Ncm.

Connection	Guide Diameter	Type	Ref.C
2.1 Hex	Ø5.0	Ratchet	ICRH2127
2.5 Hex			ICRH2523O
2.1 Hex		Handpiece	ICRH2127H
2.5 Hex			ICRH2523HO

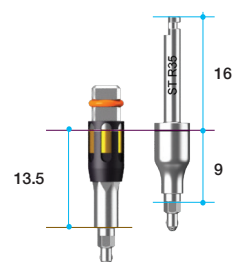

## ➔ Components for R2 Super Line Standard Kit

### Implant Carrier

- To pick up the fixture from the ampule and insert it to the osseotomy. Then turn it to clock-wise direction 2~3 times manually.
- When it gets fixation from the osteotomy, connect the handpiece adaptor and use implant motor.
- Recommended insertion torque is 45~50Ncm.

Connection	Guide Diameter	Type	Ref.C
2.5 Hex	Ø5.0	Ratchet	ICRH2523SL
	Ø6.5		ICWH2523SL

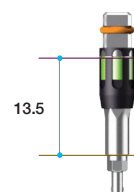

## ➔ Components for R2 UFII Standard Kit

### Implant Carrier

- To pick up the fixture from the ampule and insert it to the ossetomy. Then turn it to clock-wise direction 2~3 times manually.
- When it gets fixation from the osteotomy, connect the handpiece adaptor and use implant motor.
- Recommended insertion torque is 45~50Ncm.

Connection	Guide Diameter	Type	Ref.C
2.5 Hex	Ø5.0	Ratchet	ICRH2523UF
	Ø6.5		ICWH2523UF

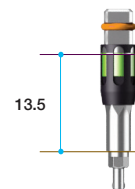

### Tap Drill [Optional]

- The purpose of tap drills in the universal kit system is insertion test. some of implant are required this procedure before final fixture insertion. choose the one-step under size of tap to protect from enlarge- ment of osteotomy.
- Recommended insertion torque and speed is 45 ~ 50Ncm, under 40 RPM.

System	Diameter	Guide Diameter	Length(mm)	Ref.C
UF	Ø3.8	Ø5.0	10	R2TD38UF
	Ø4.0			R2TD40UF
	Ø4.5			R2TD45UF
	Ø5.0	R2TD50UF		
	Ø5.5	R2TD55UF		

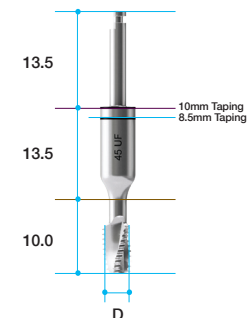

## ➔ Components for R2 ISII Standard Kit

### Implant Carrier

- To pick up the fixture from the ampule and insert it to the ossetomy. Then turn it to clock-wise direction 2~3 times manually.
- When it gets fixation from the osteotomy, connect the handpiece adaptor and use implant motor.
- Recommended insertion torque is 45~50Ncm.

Connection	Guide Diameter	Type	Ref.C
2.5 Hex	Ø5.0	Ratchet	ICRH2518IS
			ICRH2523IS
	Ø6.5		ICWH2523IS

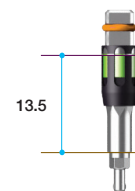

### Tap Drill [Optional]

- The purpose of tap drills in the universal kit system is insertion test. some of implant are required this procedure before final fixture insertion. choose the one-step under size of tap to protect from enlarge- ment of osteotomy.
- Recommended insertion torque and speed is 45 ~ 50Ncm, under 40 RPM.

System	Diameter	Guide Diameter	Length(mm)	Ref.C
IS	Ø3.5	Ø5.0	10	R2TD35IS
	Ø4.0			R2TD40IS
	Ø4.5			R2TD45IS
	Ø5.0	R2TD50IS		

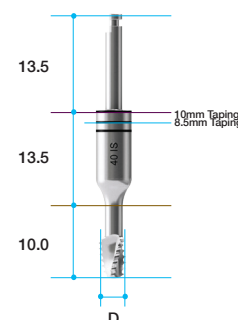

# R2 Universal Kit

Maximize the cost-effectiveness & efficiency.

Ref.C  
KAGUN3000

**When you want to do R2GATE surgery with R2 Guide™, Please inform us your favorite implant system**

Make your own R2 Surgical Kit with your favorite implant system. R2 Universal kit consists of basic drilling set which can be used for any implant system. You can add system options as “Implant Carrier”, “Cortical Bone Drill”, “Tap Drill” to your favorite implant system. The specification of final drills will be decided with treatment planning and delivered to you with R2 Guide™ will be from the R2 Design Center.

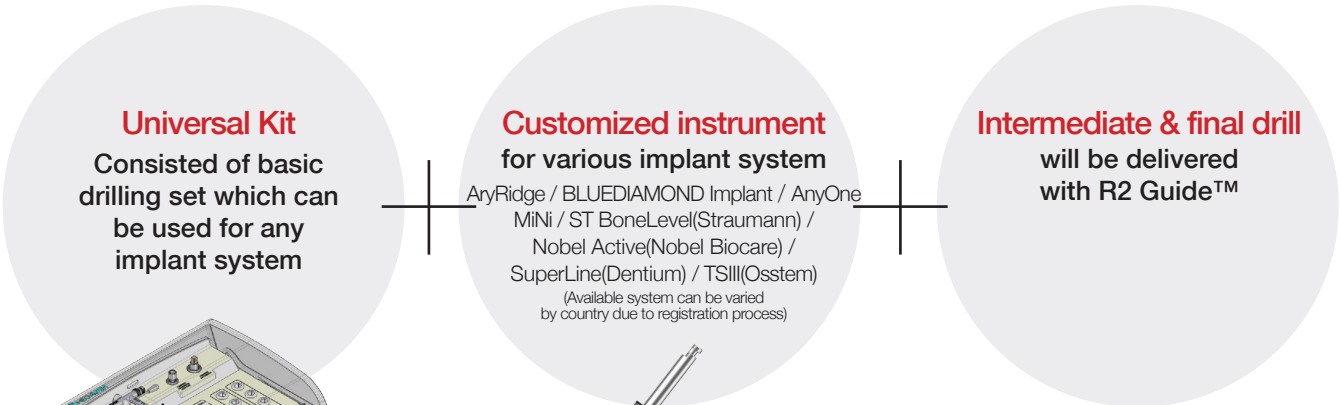

**Universal Kit**  
Consisted of basic drilling set which can be used for any implant system

**Customized instrument for various implant system**

AryRidge / BLUEDIAMOND Implant / AnyOne  
MiNi / ST BoneLevel(Straumann) /  
Nobel Active(Nobel Biocare) /  
SuperLine(Dentium) / TSIII(Osstem)  
(Available system can be varied by country due to registration process)

**Intermediate & final drill will be delivered with R2 Guide™**



# ➔ R2 Universal Kit

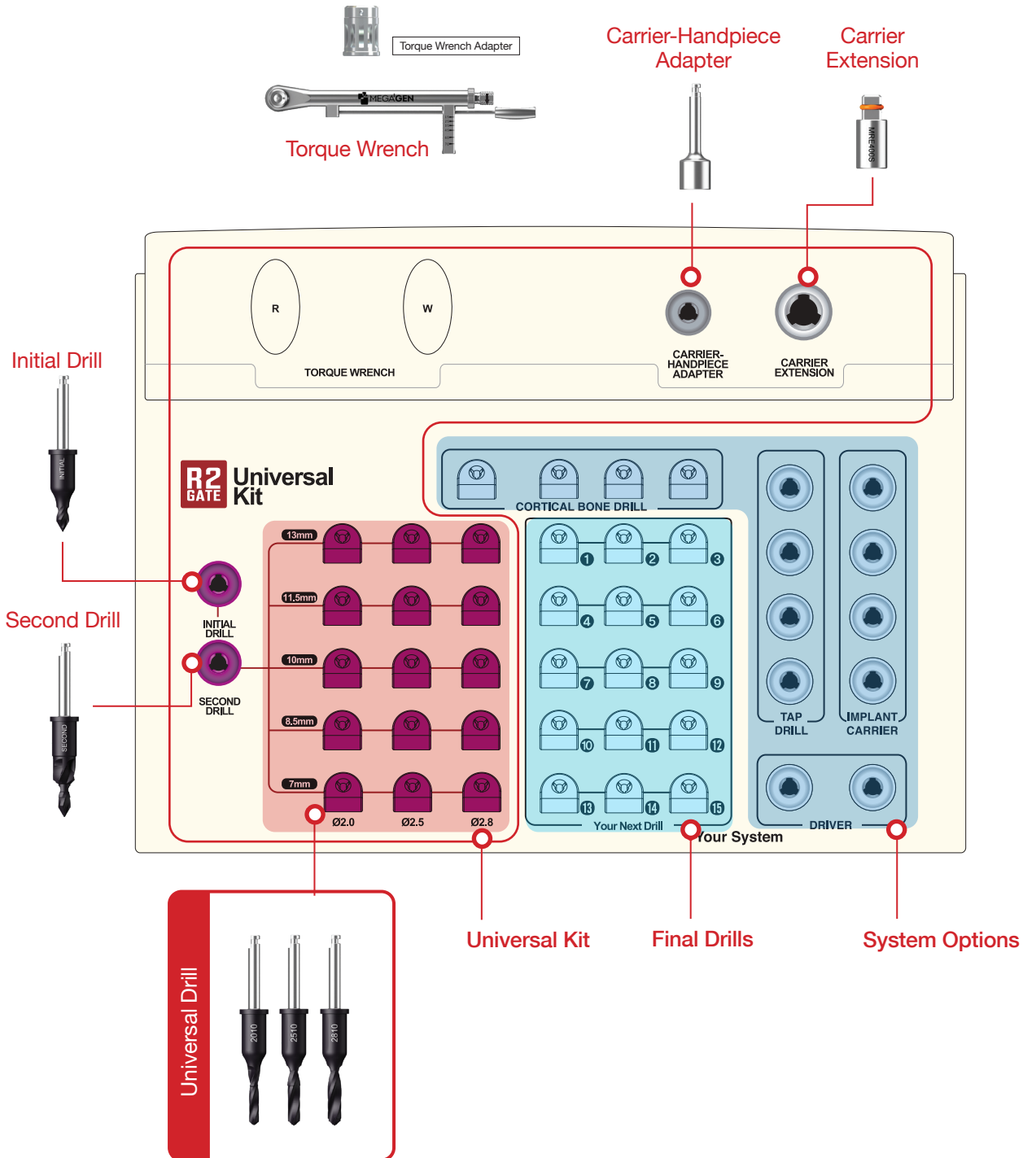

## ➔ Drills & Component for R2 Universal Kit

Basic drilling set for any implant system. It consists of initial drill, 2nd drill, universal drills and essential tools.

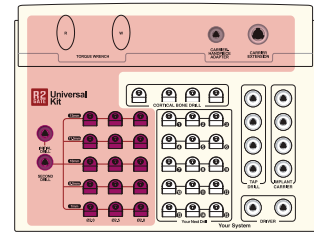

### Initial Drill

- Use the initial drill in order to mark the drilling position on the bone. Start drilling slowly, when drill guide part is fully contacted with drilling core of R2 Guide™.
- Recommended drilling speed range is 300 ~ 800 RPM with copious irrigation.

Diameter	Guide Diameter	Length(mm)	Ref.C
Ø2.6	Ø5.0	1.0	R2ID2601

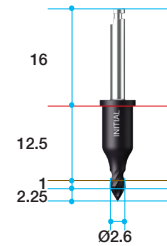

### Second Drill

- This unique step-drill(from ø2.0 to ø4.6) is used to flare out the upper cortical bone of the osteotomy.
- It helps not only the rest drilling procedure but abutment connection. In case of hard bone, if the 2nd drilling will be disturbed by thick cortical bone. Stop the drilling and try it after final drilling procedure.

Diameter	Guide Diameter	Length(mm)	Ref.C
Ø2.5	Ø5.0	5.0	R2SD2505

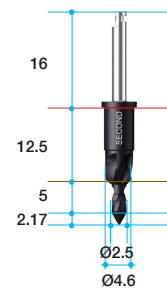

### Stopper Drill

- Universal drills consist of ø2.0, ø2.5, ø2.8 diameter to enlarge the osteotomy gradually.
- The length of drill are designed as 7.0, 8.5, 10, 11.5, 13mm for most common length of implant system.
- Recommended drilling speed range is 500 ~ 800 RPM with copious irrigation.

Diameter	Guide Diameter	Length(mm)	Ref.C
Ø2.0	Ø5.0	6.5	R2SD2007
		8.0	R2SD2008
		9.5	R2SD2010
		11.0	R2SD2011
Ø2.5	Ø5.0	12.5	R2SD2013
		6.5	R2SD2507
		8.0	R2SD2508
		9.5	R2SD2510
		11.0	R2SD2511
Ø2.8	Ø5.0	12.5	R2SD2513
		6.5	R2SD2807
		8.0	R2SD2808
		9.5	R2SD2810
		11.0	R2SD2811
		12.5	R2SD2813

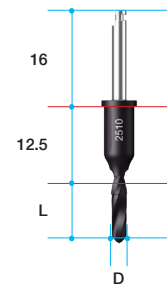

### Carrier-Handpiece Adapter

- Useful to use the handpiece for the implant placement following initial delivery of a fixture with a fixture carrier ratchet type.

Square	Ref.C
4.0	AGHA



### Carrier Extension

- To extend the length of implant carrier.

Square	Ref.C
4.0	MRE400S

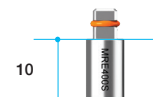

## Torque Wrench & Adapter

- Torque Wrench has torque options from 15Ncm to 45Ncm and is used for the placement of an implant and final tightening of the Abutment Screw.

Type	Ref.C
Torque Wrench	TW70
Torque Wrench Adapter(Ratchet)	TTAR100

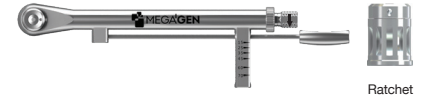

## Cortical Bone Drill[AR]

- Recommended drilling speed : 300 ~ 800 RPM

Diameter	Guide Diameter	Length(mm)	Ref.C
Ø3.4	Ø5.0	5.0	R2CD3405
Ø3.8			R2CD3805
Ø4.3			R2CD4305
Ø4.8			R2CD4805
Ø5.3	Ø6.5	5.0	R2CD5305
Ø5.8			R2CD5805
Ø6.3			R2CD6305

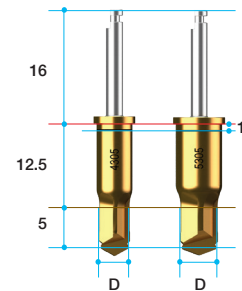

## Optional Instrument

### Narrow Crest Drill

- It is used when fixture will be slantly implanted or to flat the sloped bone surface of narrow ridge to prevent any slips during drilling.
- Design as 2-piece: drill body and housing
- Can be disassembled. Easy to clean and remove bone chips
- Can harvest autogenous bone if it is used after soft tissue

Diameter	Guide Diameter	Length(mm)	Ref.C
Ø4.0	Ø5.0	15.5(12.5/2)	NCD402

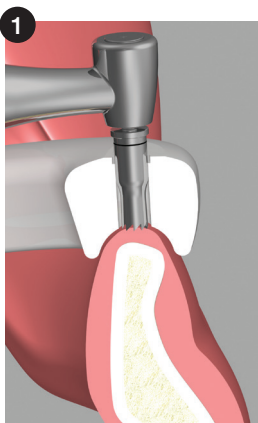
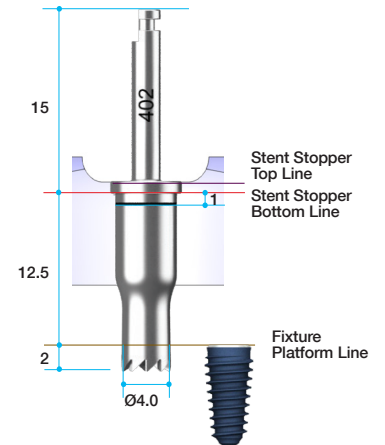
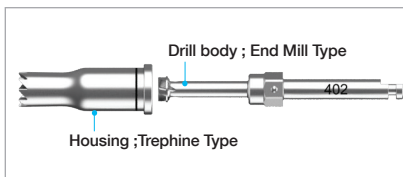

1 Set the site by drilling counter-clockwisely with low speed ( $\leq 100\text{rpm}$ )

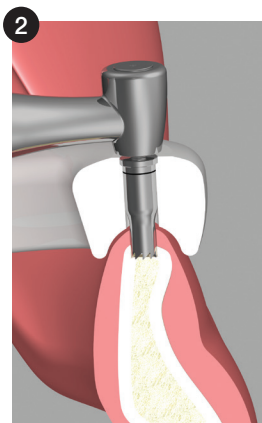

2 Start drilling clockwisely (400~600rpm)



3 Bone is now flat. Perform drilling with proper drilling sequence.

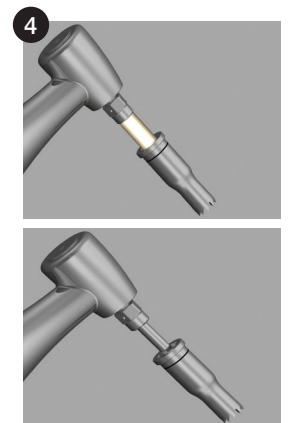

4 Disassemble body and housing after drilling to remove bone chip. Clean and sterilize after every usage.

# 1. System Options for BLUEDIAMOND IMPLANT

## Tap Drills

- This drill is used to test the insertion before placing the fixture, as required by some implant systems
- To avoid any enlargement of osteotomy, select tab drill one size smaller
- Recommended insertion torque is 45-50Ncm at speed under 40RPM

Diameter	Guide Diameter	Length(mm)	Ref.C
Ø3.9	Ø5.0	9.5	R2TD33ARO
Ø4.0			R2TD37ARO
Ø4.4			R2TD41ARO
Ø4.7			R2TD44ARO
Ø5.0			R2TD48ARO

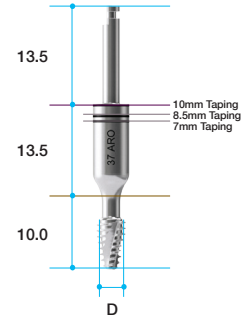

## Implant Carrier

- Use to extract fixture from ampule, then insert fixture in osteotomy and turn clockwise 2 – 3 times manually
- Once engaged in the osteotomy, connect Handpiece Adaptor & use implant motor
- Recommended insertion torque is 45-50Ncm

Connection	Guide Diameter	Type	Ref.C
2.1 Octa	Ø5.0	Ratchet	ICRO2127
2.5 Octa			ICRO2530

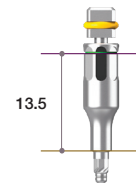

# 2. System Options for Straumann

## Tap Drill [Optional]

- The purpose of tab drills in the universal kit system is insertion test. some of implant are required this procedure before final fixture insertion. choose the one-step under size of tab to protect from enlargement of osteotomy.
- Recommended insertion torque and speed is 45 ~ 50Ncm, under 40RPM.

System	Diameter	Guide Diameter	Length(mm)	Ref.C
BoneLevel	Ø3.3	Ø5.0	10	R2TD33BL
	Ø4.1			R2TD41BL
	Ø4.8			R2TD48BL
Bone Level Taperd	Ø3.3	Ø5.0		R2TD33BLT
	Ø4.1			R2TD41BLT
	Ø4.8			R2TD48BLT
Standard & Standard Plus	Ø3.3	Ø5.0		R2TD33GL
	Ø4.1			R2TD41GL
	Ø4.8			R2TD48GL
	Ø4.8	Ø6.5	R2TD48WGL	
Taperde Effect	Ø3.3	Ø5.0	R2TD33TE	
	Ø4.1		R2TD41TE	
	Ø4.8		R2TD48TE	

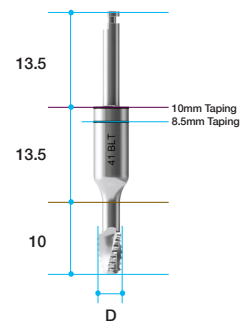

## Implant Carrier[BL & BLT]

- Can be differentiated into two types of mount based on its surface treatment and etc.
  - ICRSBL1 : Loxim Mount
  - ICRSBL2 : Used if Loxim mount is fractured
  - ICRSBN : Normal Mount
- To pick up the fixture from the ampule and insert it to the osteotomy. Then turn it to clock-wise direction 2~3 times manually.
- When it gets fixation from the osteotomy, connect the handpiece adaptor and use implant motor.
- Recommended insertion torque is 45~50Ncm.

System	Connection	Guide Diameter	Type	Ref.C
Bone Level, Bone Level Tapered	Loxim Mount	Ø5.0	Ratchet	ICRSBL1
				ICRSBL2
	Normal Mount		Handpiece	ICRSBN
	Loxim Mount			ICRSBLH

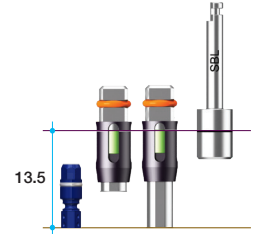

### Cautions for Bone Level\_Implant Carrier

**Loxim Mount**



**Normal Mount**



ICRSBL1

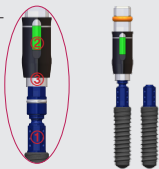

Implant carrier window ② or ③ has to be straight with undotted surface of Mount①.

ICRSBL2

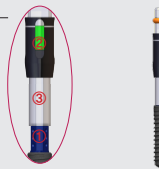

Implant carrier window ② or ③ has to be straight with undotted surface of Mount①.

ICRSBN

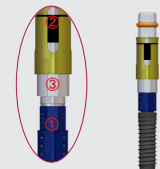

Implant carrier window ② or ③ has to be straight with undotted surface of Mount①.

### 3. System Options for Nobel Biocare

#### Implant Carrier [Optional]

- Two different implant carriers for regular stent since Ø3.5 fixture has different abutment connection- ICRH2224 : Ø3.5 fixture- ICRH2624 : Ø4.1, Ø5.0 fixture - ICWH2624
- To pick up the fixture from the ampule and insert it to the osseotomy. Then turn it to clock-wise direction 2~3 times manually.
- When it gets fixation from the osteotomy, connect the handpiece adaptor and use implant motor.
- Recommended insertion torque is 45~50Ncm.

System	Connection	Guide Diameter	Type	Ref.C
Active & Conical Connection	2.2 Hex	Ø5.0	Ratchet	ICRH2224
	2.6 Hex			ICRH2624
	2.6 Hex	Ø6.5		ICWH2624
Replace Select Tapered & Straight	Trip 1	Ø5.0	Ratchet	ICRT35RT
	Trip 2			ICWT43RT
	Trip 3	Ø6.5		ICWT50RT

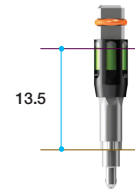

#### Tap Drill [Optional]

- The purpose of tap drills in the universal kit system is insertion test. some of implant are required this procedure before final fixture insertion. choose the one-step under size of tap to protect from enlargement of osteotomy.
- Recommended insertion torque and speed is 45 ~ 50Ncm, under 40 RPM.

System	Diameter	Guide Diameter	Length(mm)	Ref.C
Active	Ø3.5	Ø5.0	10	R2TD35NA
	Ø4.3			R2TD43NA
	Ø5.0			R2TD50NA
Conical connection	Ø3.5	Ø5.0		R2TD35CC
	Ø4.3			R2TD43CC
	Ø5.0	Ø6.5		R2TD50CC
Replace Select Straight	Ø3.5	Ø5.0		R2TD33BM
	Ø3.7			R2TD37BM
	Ø4.3	R2TD40BM		
	Ø5.0	Ø6.5	R2TD50BM	

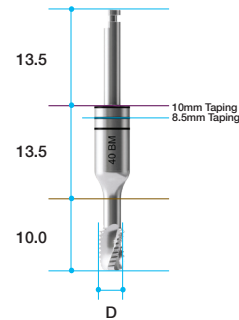

### 4. System Options for the Astra

#### Implant Carrier [Optional]

- Two different implant carriers for regular guide since Ø3.5 fixture has different abutment connection- ICRH2127OS : Ø3.0, Ø3.6, Ø4.2 fixture - ICWH2538OS : Ø4.3, Ø5.4 fixture
- To pick up the fixture from the ampule and insert it to the osseotomy. Then turn it to clock-wise direction 2~3 times manually.
- When it gets fixation from the osteotomy, connect the handpiece adaptor and use implant motor.
- Recommended insertion torque is 45~50Ncm.

System	Connection	Guide Diameter	Type	Ref.C
OsseoSpeed TX	2.1 Hex	Ø5.0	Ratchet	ICRH2127OS
	2.5 Hex	Ø6.5		ICWH2538OS

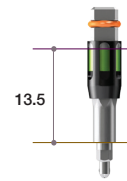

## 5. System Options for Biomet 3i

### Implant Carrier [Optional]

- Two different implant carriers for regular guide since Ø3.5 fixture has different abutment connection- ICRH2221CT : Ø3.4, Ø4.1 fixture- ICWH2711CT : Ø5.0, Ø6.0 fixture
- To pick up the fixture from the ampule and insert it to the ossetomy. Then turn it to clock-wise direction 2~3 times manually.
- When it gets fixation from the osteotomy, connect the handpiece adaptor and use implant motor.
- Recommended insertion torque is 45~50Ncm.

System	Connection	Guide Diameter	Type	Ref.C
Certain	Hex 2.2	Ø5.0	Ratchet	ICRH2221CT
	Hex 2.7	Ø6.5		ICWH2711CT

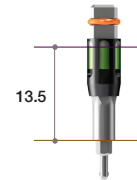

### Tap Drill [Optional]

- The purpose of tap drills in the universal kit system is insertion test. some of implant are required this procedure before final fixture insertion. choose the one-step under size of tap to protect from enlarge- ment of osteotomy.
- Recommended insertion torque and speed is 45 ~ 50Ncm, under 40 RPM.

System	Diameter	Guide Diameter	Length(mm)	Ref.C
Certain	Ø3.4	Ø5.0	10	R2TD34CT
	Ø4.1			R2TD41CT
	Ø5.0			R2TD50CT

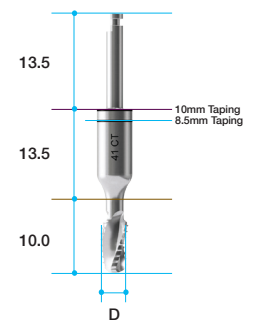

## 6. System Options for the TSIII

### Implant Carrier [Optional]

- Two different implant carriers for regular guide since Ø3.5 fixture has different abutment connection- ICRH2127 : Ø3.5 fixture- ICRH2523O : Ø4.0, Ø4.5 fixture
- To pick up the fixture from the ampule and insert it to the ossetomy. Then turn it to clock-wise direction 2~3 times manually.
- When it gets fixation from the osteotomy, connect the handpiece adaptor and use implant motor.
- Recommended insertion torque is 45~50Ncm.

Connection	Guide Diameter	Type	Ref.C
2.1 Hex	Ø5.0	Ratchet	ICRH2127
2.5 Hex			ICRH2523O
2.1 Hex		Handpiece	ICRH2127H
2.5 Hex			ICRH2523HO

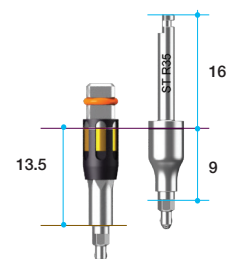

## 7. System Options for the SuperLine

### Implant Carrier [Optional]

- Two different implant carriers for regular guide since Ø3.5 fixture has different abutment connection - ICRH2523SL : Ø3.4, Ø3.8, Ø4.3 fixture - ICWH2523SL : Ø4.8 fixture
- To pick up the fixture from the ampule and insert it to the ossetomy. Then turn it to clock-wise direction 2~3 times manually.
- When it gets fixation from the osteotomy, connect the handpiece adaptor and use implant motor.
- Recommended insertion torque is 45~50Ncm.

Connection	Guide Diameter	Type	Ref.C
2.5 Hex	Ø5.0	Ratchet	ICRH2523SL
	Ø6.5		ICWH2523SL

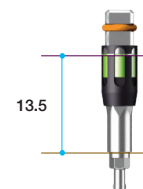

## 8. System Options for the ISII

### Implant Carrier [Optional]

- Three different implant carriers for regular guide since Ø3.5 fixture has different abutment connection - ICRH2518IS : Ø3.5 fixture - ICRH2523IS : Ø4.0, Ø4.5 fixture - ICWH2523IS : Ø5.0 fixture
- To pick up the fixture from the ampule and insert it to the osseotomy. Then turn it to clock-wise direction 2~3 times manually.
- When it gets fixation from the osteotomy, connect the handpiece adaptor and use implant motor.
- Recommended insertion torque is 45~50Ncm.

Connection	Guide Diameter	Type	Ref.C
2.5 Hex	Ø5.0	Ratchet	ICRH2518IS
			ICRH2523IS
	Ø6.5		ICWH2523IS

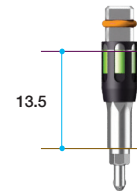

### Tap Drill [Optional]

- The purpose of tap drills in the universal kit system is insertion test. some of implant are required this procedure before final fixture insertion. choose the one-step under size of tap to protect from enlargement of osteotomy.
- Recommended insertion torque and speed is 45 ~ 50Ncm, under 40 RPM.

System	Diameter	Guide Diameter	Length(mm)	Ref.C
IS	Ø3.5	Ø5.0	10	R2TD35IS
	Ø4.0			R2TD40IS
	Ø4.5			R2TD45IS
	Ø5.0	Ø6.5		R2TD50IS

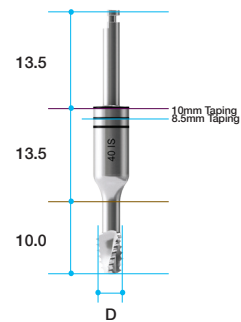

## 9. System Options for the UFII

### Implant Carrier [Optional]

- Two different implant carriers for regular guide since Ø3.5 fixture has different abutment connection - ICRH2523UF : Ø3.8, Ø4.0, Ø4.5, Ø5.0, Ø5.5 fixture
- To pick up the fixture from the ampule and insert it to the osseotomy. Then turn it to clock-wise direction 2~3 times manually.
- When it gets fixation from the osteotomy, connect the handpiece adaptor and use implant motor.
- Recommended insertion torque is 45~50Ncm.

Connection	Guide Diameter	Type	Ref.C
2.5 Hex	Ø5.0	Ratchet	ICRH2523UF
	Ø6.5		ICWH2523UF

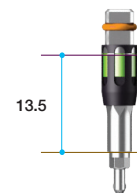

### Tap Drill [Optional]

- The purpose of tap drills in the universal kit system is insertion test. some of implant are required this procedure before final fixture insertion. choose the one-step under size of tap to protect from enlargement of osteotomy.
- Recommended insertion torque and speed is 45 ~ 50Ncm, under 40 RPM.

System	Diameter	Guide Diameter	Length(mm)	Ref.C
UF	Ø3.8	Ø5.0	10	R2TD38UF
	Ø4.0			R2TD40UF
	Ø4.5			R2TD45UF
	Ø5.0	Ø6.5		R2TD50UF
	Ø5.5	R2TD55UF		

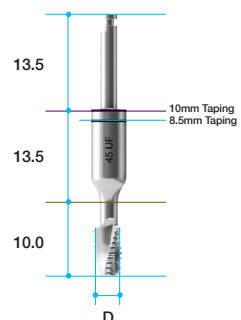

## ➔ Final Drill Option

### Stopper Drill[Straight]

For all implant system

- Common use
- Step back type drilling
- Provided from local R2GATE Design Center to users. The size of disposable drills are decided depend size on treatment planning regarding to fixture size and bone density of patient.
- Recommended drilling speed is 300 ~ 800 RPM.
- Final drill.
- The base is disposable and can be made for permanent under your order.

Diameter	Guide Diameter	Length(mm)	Ref.C
Ø3.4		7.0	R2PS3407
		8.0	R2PS3408
		9.0	R2PS3409
		10.0	R2PS3410
		11.0	R2PS3411
		12.0	R2PS3412
Ø3.8	Ø5.0	13.0	R2PS3413
		7.0	R2PS3807
		8.0	R2PS3808
		9.0	R2PS3809
		10.0	R2PS3810
		11.0	R2PS3811
Ø4.3		12.0	R2PS3812
		13.0	R2PS3813
		7.0	R2PS4307
		8.0	R2PS4308
		9.0	R2PS4309
		10.0	R2PS4310
Ø4.8		11.0	R2PS4311
		12.0	R2PS4312
		13.0	R2PS4313
		7.0	R2PS4807
		8.0	R2PS4808
		9.0	R2PS4809
Ø5.3	Ø6.5	10.0	R2PS4810
		11.0	R2PS4811
		12.0	R2PS4812
		13.0	R2PS4813
		7.0	R2PS5307
		8.0	R2PS5308
Ø5.8		9.0	R2PS5309
		10.0	R2PS5310
		11.0	R2PS5311
		12.0	R2PS5312
		13.0	R2PS5313
		7.0	R2PS5807
		8.0	R2PS5808
		9.0	R2PS5809
		10.0	R2PS5810
		11.0	R2PS5811
		12.0	R2PS5812
		13.0	R2PS5813

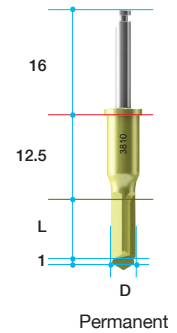

# R2 Narrow Kit

Ref.C

KAGNS3000

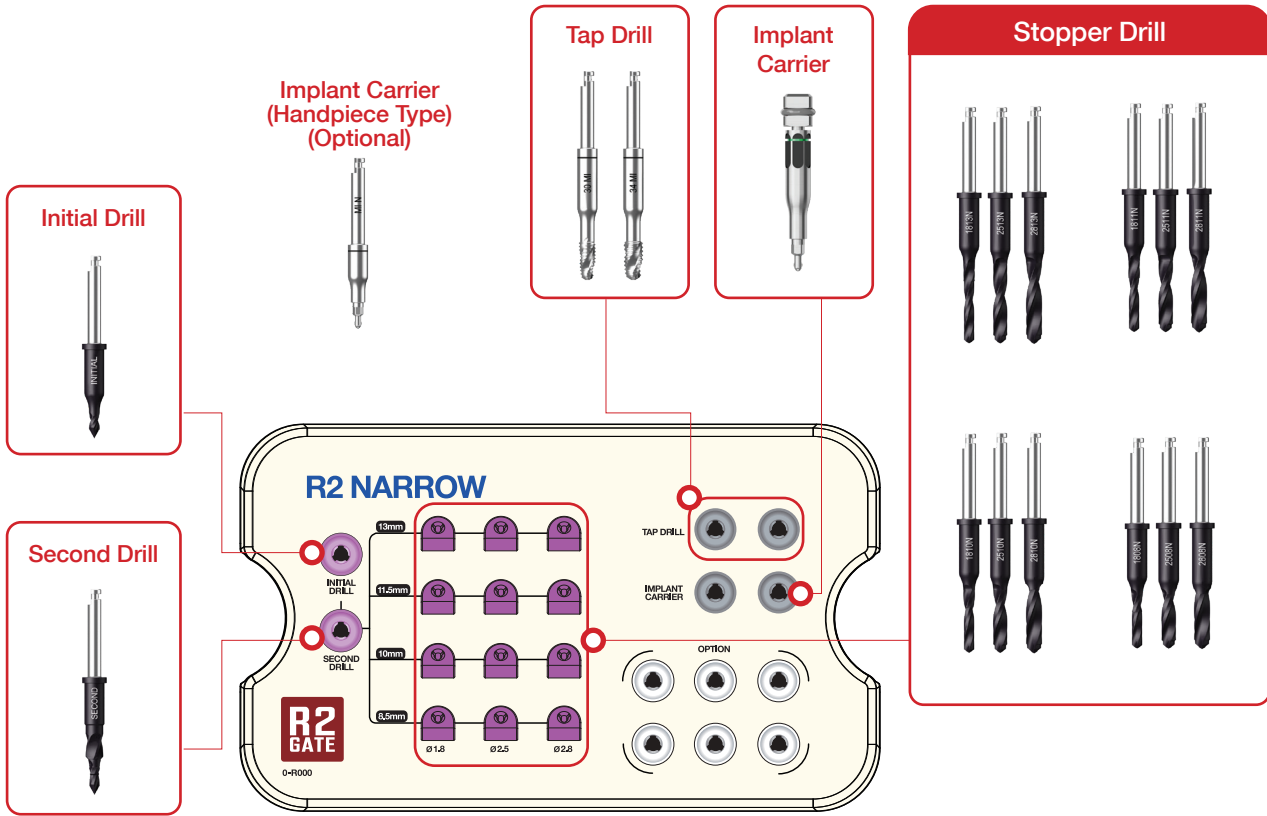

## When do we use R2 Narrow Kit?

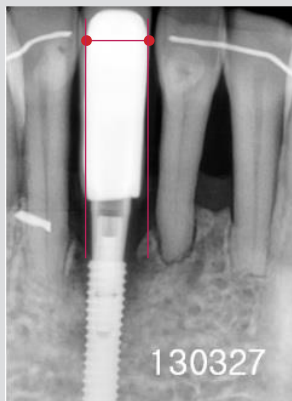

[Mandible single case]  
When  $\varnothing 5.0$  stent cannot be fabricated due to narrow distance between the teeth.



[Mandible multiple case]  
When fixture cannot be placed near adjacent teeth due to large stent core on regular stent.

### Regular VS Narrow Stent Guide Core

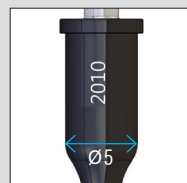

Regular Stent  
[Guide Core  $\varnothing 5$ ]



Narrow Stent  
[Guide Core  $\varnothing 3.5$ ]

## ➔ Components of R2 Narrow Kit



### Initial Drill

- Use the initial drill in order to mark the drilling position on the bone. Start drilling slowly, when drill guide part is fully contacted with drilling core of R2 Guide™.
- Recommended drilling speed range is 300 ~ 800 RPM with copious irrigation.

Diameter	Guide Diameter	Length(mm)	Ref.C
Ø1.9	Ø3.5	1.0	R2ID1901N

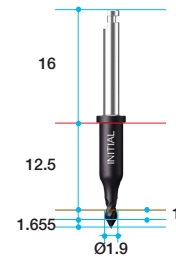

### Second Drill

- This unique step-drill(from Ø2.0 to Ø3.1) is used to flare out the upper cortical bone of the osseotomy.
- It helps not only the rest drilling procedure but abut-ment connection. In case of hard bone, if the 2nd drilling will be disturbed by thick cortical bone. Stop the drilling and try it after final drilling procedure.

Diameter	Guide Diameter	Length(mm)	Ref.C
Ø1.8	Ø3.5	5.0	R2SD1805N

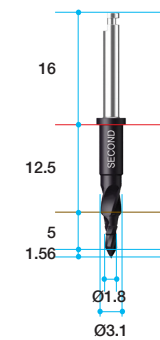

### Stopper Drill

- Universal drills consist of Ø2.0, Ø2.5, Ø2.8 diameter to enlarge the osteotomy gradually.
- The length of drill are designed as 7.0, 8.5, 10, 11.5, 13mm for most common length of implant system.
- Recommended drilling speed range is 500 ~ 800 RPM with copious irrigation.

Diameter	Guide Diameter	Length(mm)	Ref.C
Ø1.8	Ø3.5	8.0	R2SD1808N
		9.5	R2SD1810N
		11.0	R2SD1811N
		12.5	R2SD1813N
Ø2.5		8.0	R2SD2508N
		9.5	R2SD2510N
		11.0	R2SD2511N
		12.5	R2SD2513N
Ø2.8		8.0	R2SD2808N
		9.5	R2SD2810N
		11.0	R2SD2811N
		12.5	R2SD2813N



### Tap Drill

- The purpose of tap drills in the universal kit system is insertion test.
- Recommended insertion torque and speed is 45 ~ 50Ncm, under 40 RPM.

Diameter	Guide Diameter	Length(mm)	Ref.C
Ø3.0	Ø3.5	8.0	R2TD30MI
Ø3.4			R2TD34MI

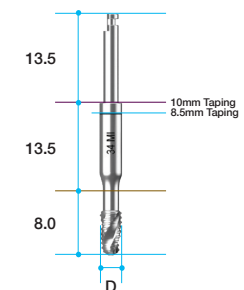

### Implant Carrier

- To pick up the fixture from the ampule and insert it to the osseotomy. Then turn it to clock-wise direction 2~3 times manually.
- When it gets fixation from the osteotomy, connect the handpiece adaptor and use implant motor.
- Recommended insertion torque is 45~50Ncm.

System	Connection	Guide Diameter	Type	Ref.C
MiNi	1.7 Hex	Ø3.5	Ratchet	ICNH1722
			Handpiece	ICNH1722H
Advanced Intermezzo	2.3 Hex		Cuff 2.0	*ICNH2302
			Cuff 3.5	*ICNH2303

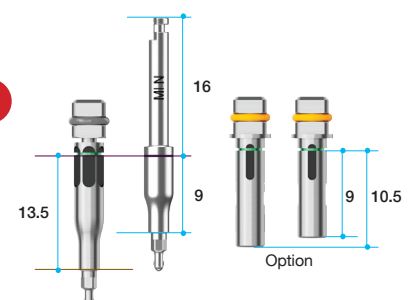

(\*) Separate sales item.

# Anchor Kit

For an edentulous case or free end case, R2 Guide™ is fixed with Anchor Pins specially designed for stability of the R2 Guide™.

System	Ref.C
AnyRidge	KAGAS3000
BLUEDIAMOND	KAGAS3002
AnyOne	KAGAS3001

You can order your own Anchor kit for your favorite implant system

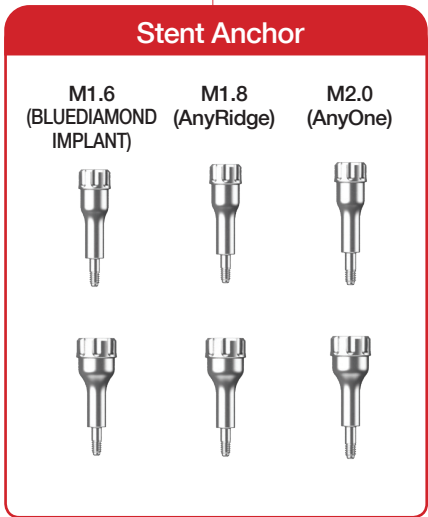

## ➔ Components for Anchor Kit



### Anchor Pin

- Distinguish the length size by the numbers of Line marking
- Connect through Trox Tip

Diameter	Length(mm)	Marking Line	Ref.C
Ø2.0	5.5	1	TCMACP2015
	8.0	2	TCMACP2018
	10.5	3	TCMACP2020

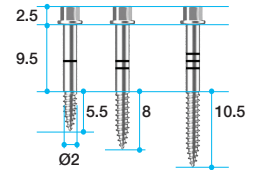

### Stent Anchor

- Connect through Hand & Hand Driver

Thread	Guide Diameter	Ref.C
M1.6 (BLUEDIAMOND IMPLANT)	Ø5.0	AGSANR16
	Ø5.0	AGSARR16
	Ø6.5	*AGSARW16
M1.8 (AnyRidge)	Ø5.0	AGSAR18
	Ø6.5	AGSAW18
M2.0 (AnyOne)	Ø5.0	AGSAR20
	Ø6.5	AGSAW20

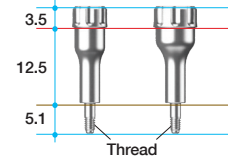

(\*) Separate sales item.

### Trox Tip

Length(mm)	Ref.C
80	AGTT80



### Tip Driver

Ref.C
TD



## ►► How to use Anchor Kit?

### Case 1.

When it is possible to get stability from neighboring teeth. (No need to use the Anchor kit)

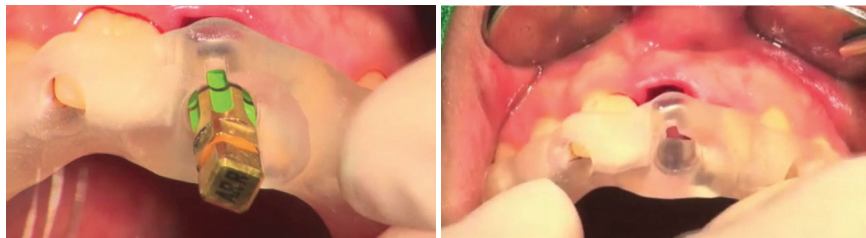

Place the R2 Guide™ by placing it onto the neighboring teeth.

### Case 2.

When it is hard to get stability from fully edentulous case or neighboring teeth.



1. Fix the R2 Guide™ temporarily by asking patient to bite the R2 Guide™ using a resin or other tools.
2. Please use the Pin that R2GATE™ program selected, and place that Pin on the Driver Tip.
3. Insert the Pin into the R2 Guide™ that the patient is biting, and turn it into clockwise to fix the R2 Guide™ to bone.

\*Make a hole on the Guide using  $\varnothing 2.0$  Drill if a density of the bone is high. Then, insert the Anchor Pin into the hole.

### Case 3.

- When it is necessary to re-implant a fixture after separating the R2 Guide™.
- When the stability of the R2 Guide™ is weak even though all planned Anchor Pins are used (This is only for the cases with edentulous jaws and implantations of three or more fixtures).

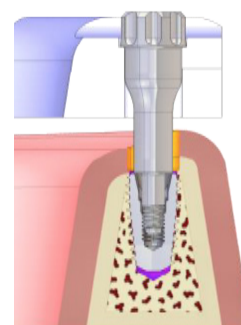
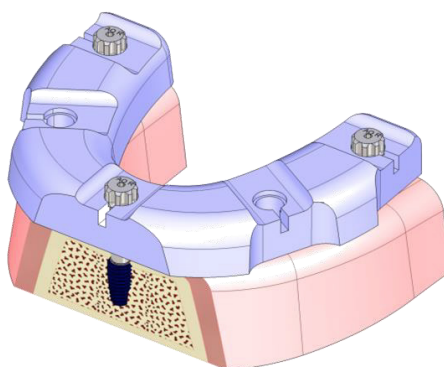

#### \* Cases for re-implant a fixture after failure

1. Check the condition of an implanted fixture after a separation of a R2 Guide™. Evulse the fixture when the implantation is considered as a failure for lack of stability or a path is inaccurate.
2. Replace the R2 Guide™. Insert the R2 Guide™ Anchor to the R2 Guide™ Hole of the neighboring fixture, and place the R2 Guide™ by turning it into clockwise.

#### \* When it is hard to get stability of the R2 Guide™ by an Anchor Pin only

1. When the stability of a fixture by an Anchor Pin only is low, start an implantation from molar areas. Then, connect the R2 Guide™ Anchor with an installed fixture to increase stability.

# MegaGen Digital Solution

572 MegaGen DIGITAL Work Flow

574 Digital Equipment

574 I. Intra-Oral Scanner

574 1. MEDIT i700 wireless

575 2. Medit i700

576 3. Medit i600

580 II. Model Scanner

582 III. Auto - CAD Solution

583 IV. Auto - CAM Lab Solution

583 1. MEG Printer 2Q

584 2. BX5 Plus

585 3. X5

586 4. R2iCE Multi-layer zirconia

587 5. Hass Amber Mill

588 Digital Material

588 I. ZrGEN

588 II. TiGEN

# MegaGen Digital Solution WORK FLOW

## Digital Equipment



CBCT



MEDIT i-series intra oral scanner

3D Imaging



N2 Unit Chair



T-scanner (model)

## Materials



R2 TRAY



Scan Abutment

## Important for Dentists

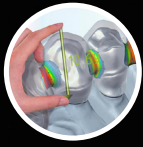

## MegaGen Provides CAD/less Solution!

Just send a scan data. MegaGen R2 Digital Center will take care of the design. The designed file will be sent to you within an hour.

### Tx. planning & Design

### Digital Cad Design

### In-lab Equipment



R2GATE® Premium

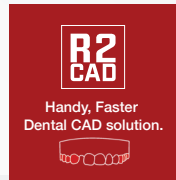

R2CAD



MEG-Printer IIQ



BX5 Plus



X5



Surgical KIT

R2 Package



Resin



PMMA Abutment



TIGEN Abutment

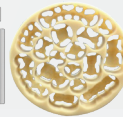

Blocks



Blocks



R2 Guided Surgery & ONE-DAY Implant™

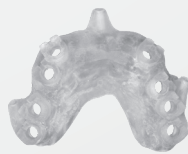

R2 Guide™



R2 Guide™



Zr. Custom



Temporary Crown



Abutment-integrated semi-crown



Ti-Custom



Final Crown

# Digital Equipment

## I. Intra-Oral Scanner

### 1. MEDIT i700 wireless



#### i700 wireless specifications

Scanning	Up to 70 FPS	
Imaging Technology	3D full color streaming capture	
Accuracy (full arch)	10.9 µm + 0.98	
Handpiece	Weight	328g (included battery)
	Dimensions	313 x 44 x 47.4mm
Tip	Autoclavable	150 times
	Reversible tip	yes
UV-C LED Disinfection	yes	
Remote Control Mode	yes	
Connectivity	Wireless (USB 3.1 wireless Hub)	

## Medit i700 wireless

Magic made easy with a simple touch

The convenience of wireless is added to the speed and function of the i700. Scanning is possible in any environment.

- Wireless system
- Superfast scanning
- High Accuracy
- NO Annual fee
- Free S/W update
- Jog dial



# I. Intra-Oral Scanner **NEW**

## 2. MEDIT i700

i700 specifications		
Scanning	Up to 70 FPS	
Imaging Technology	3D full color streaming capture	
Accuracy (full arch)	10.9 µm + 0.98	
Handpiece	Weight	245g
	Dimensions	248 x 44 x 47.4mm
Tip	Autoclavable	150 times
	Reversible tip	yes
UV-C LED Disinfection	yes	
Remote Control Mode	yes	
Connectivity	USB 3.1 Gen 1 (Cable length 2.0m)	

## Medit i700

Better for patients, easier for Dentists

Top class scanning speed of 70fps  
and light weight  
Best seller Intra oral scanner.

- Superfast scanning
- High Accuracy
- NO Annual fee
- Free S/W update
- Jog dial



**NEW**

## I. Intra-Oral Scanner

# 3. MEDIT i600

### i600 specifications

Scanning	Up to 35 FPS	
Imaging Technology	3D full color streaming capture	
Accuracy (full arch)	10.9 $\mu$ m + 0.98	
Handpiece	Weight	328g (included battery)
	Dimensions	313 x 44 x 47.4mm
Tip	Autoclavable	100 times
	Reversible tip	yes
UV-C LED Disinfection	no	
Remote Control Mode	no	
Connectivity	USB 3.1 Gen 1 (Cable length 2.0m)	

## Medit i600

Digital dentistry at Your Finger tips

Best cost-effective oral scanner.

The i600 uses the same SW as the i700 (i700 wireless).

Start digital dentistry at an affordable price.

- Fast scanning
- High Accuracy
- NO Annual fee
- Free S/W update
- Reasonable price



## ➔ **MEDIT i-series intra oral scanner**

Category		i700 wireless	i700	i600
Scanning		Up to 70 FPS	Up to 70 FPS	Up to 35 FPS
Imaging Technology		3D full color streaming capture		
Accuracy (full arch)		10.9 µm + 0.98		
Handpiece	Weight	328g (included battery)	245g	245g
	Dimensions	313 x 44 x 47.4mm	248 x 44 x 47.4mm	
Tip	Autoclavable	150 times	100 times	
	Reversible Tip	Yes	Yes	Yes
UV-C LED Disinfection		Yes	Yes	No
Connectivity		Wireless	USB 3.1 Gen 1	USB 3.1 Gen 1

*Patient chair time is down!  
Staff comfort and dentists'  
treatment approval is up!*



## ►► MEDIT i-series intra oral scanner

### A.I. Abutment & Scanbody Matching

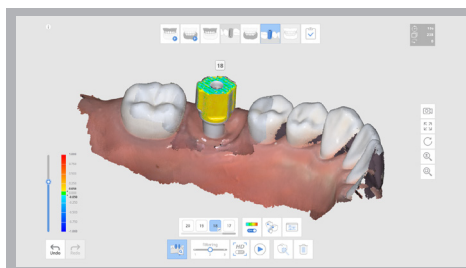

This function allows you to match scan abutments and scan bodies, thus saving time in instances of poor scanning environments. You can select the appropriate library for your tooth. When you scan the corresponding tooth, the scan abutment and scan body are automatically matched and aligned with the scan data. The aligned library data can be used for downstream work such as design. A manual alignment option is also available.

### Pre-Operation Scan

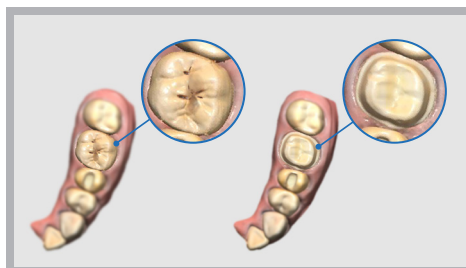

You can perform a pre-operation scan of a patient's teeth and utilize this data for a variety of uses. With this pre-operation scan data, the post-operation scan can be performed more quickly and easily. The data can also be used as reference data in the modeling process to assist you in creating more natural prosthesis.

### Face Scan

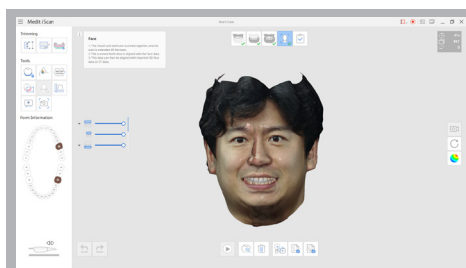

You can perform a face scan with the i-series scanner and align it with imported data such as 3D face scan data taken with other facial scanners or 3D bone data which has been converted from DICOM files taken via CT.

### Smart Scan Filtering

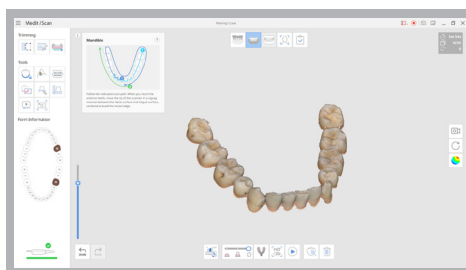

This feature helps to remove unnecessary soft tissue data which is one of the biggest challenges when performing scans. The three filter options allow you to choose the amount of soft tissue you wish to capture in your scan data.

### Impression Scan

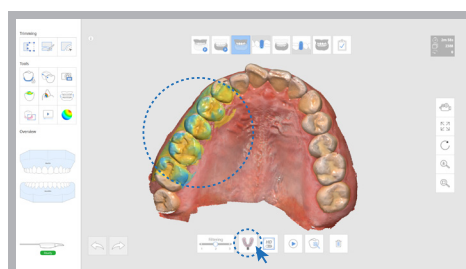

This function supports composite scanning operations which use both embossed oral scan data and engraved impression scan data. With just a simple scan, both data can be sorted and merged in real-time and used for modeling.

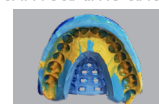

## Fast impression taking Reduce chair time

### 1. Maxillary/mandibular, full mouth impressions can be completed in 3 minutes!

- at maximum scan speed, 70fps: 30 seconds for a full mouth scan or; 20 seconds for one side
- more precise and faster full mouth scan with Smart arch scan

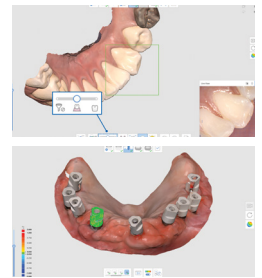

### 2. With the digital approach, full mouth implant impression can be taken in just 10 minutes!

- Scan with a digital impression coping mounted, AI then automatically finds a matching coping for the implant system.

## Free SW enhancing patient approval for esthetic prosthetic, orthodontic or implant procedures

### 1. Consult patients on smile instantly with the Smile Design app

- Simulate procedures and give consultations on treatments for teeth most suitable for patients using various teeth in the Smile Tooth library.
- Various patient consultation modes are available including orthodontic bracket attachment, tooth size and color change.



### 2. Increase patient treatment approval by presenting before and after images of orthodontic or prosthetic treatments.

- Orthodontic simulation enables consultation by presenting analysis of tooth movements, checking gingival changes, and even expected treatment outcomes.
- Teeth movements and positions, and gum changes after implant procedures can also be simulated.
- The results of simulation used for consultation, and patients' oral photo data can be transmitted to patients through MEDIT Case talk.

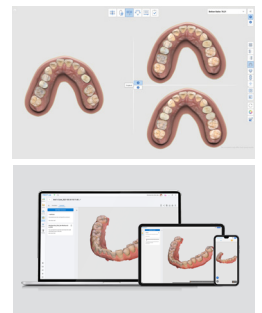

## Use i-series scanner digital treatment in various ways.

### 1. Patient consultation, consult on esthetic prosthetics and send the result to patient smartphone.



- i-series scanner
- Digital scan & take smile photos
- Smile design, simulate esthetic prosthetic procedure
- patient consultation
- Send the result to patient's smartphone using Case talk

### 2. Flipper digital scanning / flipper fabrication before extraction



- before/after extraction
- Scan patient mouth with i-series scanner
- Fabricate digital flipper
- send to lab
- patient consultation
- Set the flipper in the mouth after extraction

### 3. Implant prosthetics easy & fast implant impression taking/customized abutment



- Implant surgery
- Connect healing abutment
- i-series scanner
- Scan healing abutment
- send to lab
- Fabricate custom-abutment
- patient visit
- Set highly satisfactory custom-abutment.

### 4. Temporary Denture easy denture fabrication with denture scan



- i-series scanner
- Scan patient denture with i-series scanner
- send to lab
- Send digital denture to lab
- lab communication
- Relining / Rebased
- patient visit
- Set temporary denture before/after implant surgery

**NEW**

## II. Model Scanner

# 1. Medit T-Series

### Equipment Specifications (T710 / T510 / T310)

Resolution of camera	Mono 5.0(MP) x 4	Mono 5.0(MP) x 2	Mono 5.0(MP) x 2
Point spacing	0.040 mm		
Scan area	100mm x 73mm x 60mm		
Scan principle	Phase-shifting optical triangulation		
Size	505mm x 271mm x 340 mm		
Weight	15 kg		
Light source	LED, 150 ANSI-lumens, Blue LED		
Connection	USB 3.0 B Type		
Power	AC 100-240V, 50-60 Hz		
Accuracy (ISO 12836)	4µm	7µm	9µm
Full arch scan speed	8 sec(7cut)	12 sec(7cut)	18 sec(7cut)
Full arch impression scan speed	45 sec	X	X
Auto-elevation	<input type="radio"/>	<input type="radio"/>	<input type="radio"/>
Color texture	<input type="radio"/>	<input type="radio"/>	<input type="radio"/>
Flexible scanning	<input type="radio"/>	<input type="radio"/>	Optional
Articulator scanning	<input type="radio"/>	<input type="radio"/>	Optional
Replica denture	<input type="radio"/>	Optional	Optional
Orthodontic scanning	<input type="radio"/>	Optional	Optional
Impression scanning	<input type="radio"/>	X	X

## Our fastest, yet again

From the company that brought you the first blue-light tabletop scanner, introducing the Medit T710, the fastest Medit tabletop scanner you have yet to experience.



- Superfast scanning
- High-resolution cameras
- High accuracy
- Auto-elevation
- Open system



## Do more with less effort

We've always prioritized simplicity when developing our solutions. Because we want to ease your work. So we are proud to present to you our new T-Series dental tabletop scanners which allow you to do more with less effort.

### Auto-elevation

We've done away with stacking half-jigs to save you the hassle of adjusting your scanning object every time. Let the scanner decide the scanning height for your object with our auto-elevation feature.

### Wider scan area

Scan more objects at the same time thanks to the wider scan area of our T-Series scanners!

### No blind spots

The 4 cameras in the T710 are positioned in a way to ensure that there are no blind spots in your scan data. It only takes one scan to get the full data!

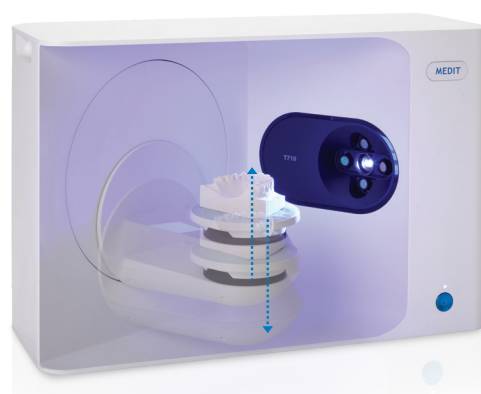

## Convenience

### Flexible multi-die scanning

Make your work more efficient by using the flexible multi-die to scan a full-arch or partials with multiple dies simultaneously.

Conventional

5 steps



Flexible multi-die

2 steps



## Most versatile articulators integration

### Full-size articulator scanning

To reproduce the exact occlusion orientation, nothing beats scanning the occlusion in the articulator itself. We've designed our T-Series to accommodate any articulator available in the market, comfortably.



**NEW**

# III. Auto - CAD Solution

## 1. R2CAD

Ref.C

R2-CAD

Chairside CAD that anyone can use easily

- Implant module (Cuff TiGEN, PMMA Abutment)
- Provisional Crown
- Mesh Aligner
- 2D Cross section view
- Model Builder
- Shortcut keys by function

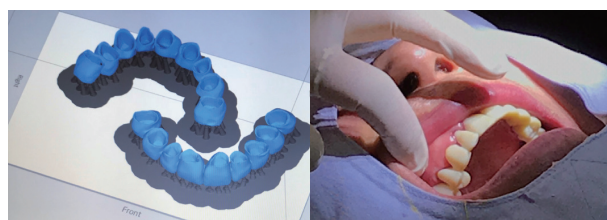
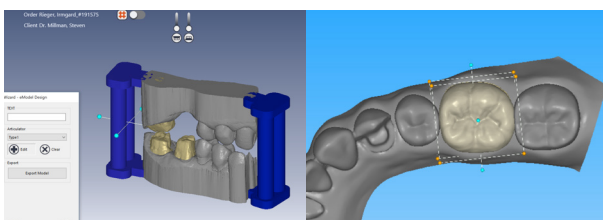
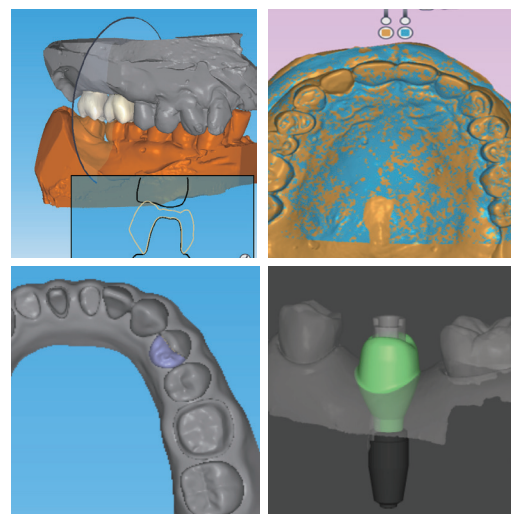

### Best compatibility with oral scanners

Modeless case, is it difficult?  
R2CAD Model Builder is installed as standard.  
Digital modeling of oral scan files enables more precise production.

### Clinical validation completed

Excellent fit and work convenience verification in clinical cases with cad data compatible with any equipment has been completed.

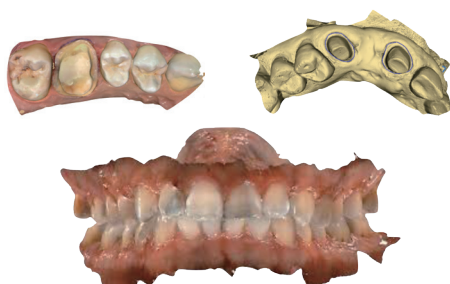

**R2  
CAD**

Handy, Faster  
Dental CAD solution.



Download

<https://www.r2gate.com/r2cad>

**NEW**

# IV. Auto - CAM Lab Solution

## 1. MEG-Printer IIQ

### MEG PRINTER IIQ SPECIFICATIONS

Printing Method	DLP (Digital Light Processing)
Build Size	100 x 60 x 70mm
Build thickness	25 $\mu$ m ~ 100 $\mu$ m
Light Lamp	LED
Printing Materials	Light Curing Resin
Spec	W310 x D210 x H350mm Weight : 10kg



### Pragmatical 3D-Printer for Clinic

- Simple procedures.
- Fast modeling time.
- Accurate result.
- Cost-effective & User friendly.
- Build time (25min)

#### Temporary crowns and bridges



Printing time : 20-25 min  
Accuracy avg. 40 $\mu$ m

#### Surgical guides

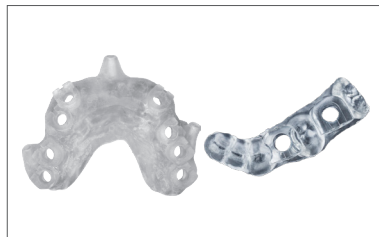

Printing time : Full arch 40-50 min  
Half 25-30 min  
Accuracy avg. 50 $\mu$ m

#### Dental models



Printing time : 40-50 min  
Accuracy avg. 50 $\mu$ m

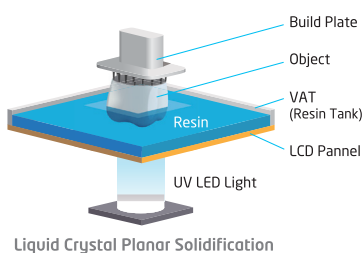

#### MEG-PRINTER IIQ Technology

MEG-PRINTER IIQ utilizes LCD technology, the ones used in mobile phones. LCPS provides fast printing with a high precision and an improved uniformity in a compact conventional printer size body.



#### Disposable vats for easy management

MEG-PRINTER IIQ adopted the disposable vats to guide users to have less trouble managing vats and reduce wasted resin material

**NEW**

# IV. Auto - CAM Lab Solution

## 2. BX5 Plus

### BX5 Plus SPECIFICATIONS

Axis / Type	5 Axes / Wet & Dry (option)
Tool Pocket	10ea
Size	W: 481mm / D: 511mm / H: 742mm
Weight	70kg
Material	TIGEN Abutment, Glass Ceramic, Hybrid Ceramic, PMMA, Wax, Zirconia



## ChairSide Digital Total Solution

- One-stop solution - from guide thru customized abutment, temporary crown, & even final crown

### Applications

#### Disc type (Dry & Wet)

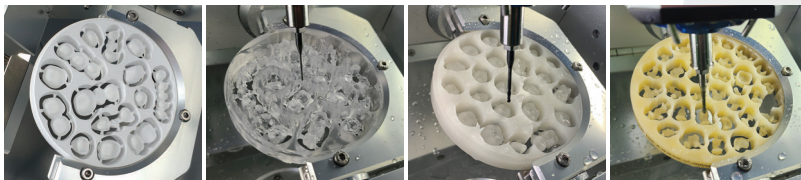

Zirconia (Dry option)    Surgical Guide (Wet)    PMMA (Wet)    Hybrid Resin (Wet)

#### Cerec rod type

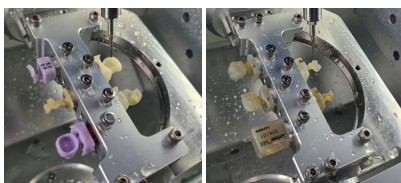

Glass Ceramic    Hybrid Resin

#### Pre-milled type

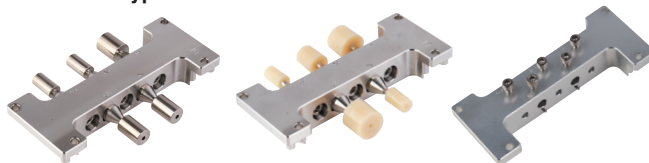

TIGEN Abutment    PMMA Abutment    For NT-Trading, Medentika (Optional pre-milled jig)

### Materials

#### Disc type



R2ICE Multi-layer zirconia Refer to Page. 586    WAX



PMMA Block (Guide, Temp. Cr.)    Multi-Layered PMMA Block

#### Cerec rod type



Glass ceramic Refer to Page. 587    Hybrid resin

#### Pre-milled type



TIGEN Abutment Refer to Page. 601    PMMA Abutment Refer to Page. 593    Reverse Jig Connector Refer to Page. 606

**NEW**

# IV. Auto - CAM Lab Solution

## 3. X5

### X5 SPECIFICATIONS

Axis / Type	5 Axis / Wet
Tool Pocket	9ea
Size	W: 392 / D: 549 / H: 575 (mm)
Weight	36kg
Material	Zirconia, Hybrid Ceramic, PMMA, Wax



### Digital Crown Solution

- More accurate prosthetic CAD/CAM with minimal investment
- Compact size for easy installation
- 5-axis low-noise milling

#### Produce more accurate prostheses

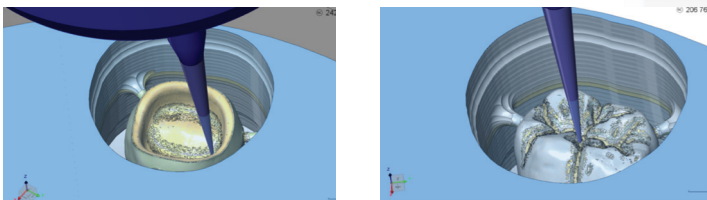

- Improved reproducibility due to final processing with Ø0.3mm tool (rival machines stop at Ø0.6mm)
- Inner corner machining in case of severe undercut
- Improved occlusal micro-area milling

#### Easy design functions & program operation

- Free installation, free training, NO annual fee

#### Simple auto-calibration with just one click!

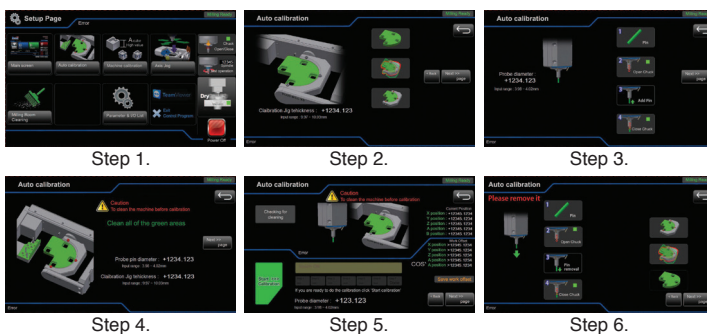

1. Zirconia  
Production time: 20min / crown



2. PMMA  
Production time: 20min / crown



3. Hybrid Ceramic  
Production time: 15min / inlay



4. Wax  
Production time: 10min / crown

**NEW**

## IV. Auto - CAM Lab Solution

# 4. R2iCE Multi-layer zirconia

### R2iCE Specifications (AT / PT)

	Product	AT	PT	
Common	Transparency	48%	45%	
	Flexural Strength	800 ~ 1,100 Mpa	1,100 ~ 1,350 Mpa	
Disk type	Height	12/14/16/ 18/ 20/ 22/ 25/ 30		
	Shade	A1 / A2 / A3 / A3.5 / A4 / B1 / B2		
CEREC type	Product	C800ML	C1100ML	
	Flexural Strength	800 Mpa	1,100 Mpa	
	Shade	A2, A3	A2, A3	A2
	Size (LxWxHmm)	55 x 19 x 15.5	55 x 19 x 15.5	65 x 25 x 22
	Indication	Max 3 unit	Max 3 unit	Max 5 unit

## Make your own esthetic zirconia crowns

- Increased daily efficiency for making prosthetics
- Reduced production time for zirconia crowns improves patient scheduling
- Letting you determine the quality of your crowns



- Pre-formed layers provide gradation effect without separate coloring, making it easy to achieve the desired shade
- Mill multiple crowns with different shades from one block
- Use CAM software to fine-tune top, middle, & bottom shades



### Coloring & stain work DOWN! Time efficiency UP!

- Determine correct shade within 1 min (single unit)
- Produce your own superior prosthetics in less time



### VITA classical shade guide

- 4 gradations similar to natural teeth + 16 shade line-up from A1 to D4



### Good light transmittance & excellent strength

- Esthetic anterior zirconia prosthetics with good light transmittance & excellent color tones
- 1100~1300mpa for posterior, where strength is important (850~1150mpa for anterior)
- No problem with warping in case of 5-unit bridge

### Clinical Cases



Made by CDT. Beom-Jin Choi

Made by DT. Young Kyu Park

**NEW**

# IV. Auto - CAM Lab Solution

## 5. Hass Amber Mill

### Hass Amber Mill Specifications

Materiel	Lithium Disilicate-Based		
Size	C12	10 x 12 x 15mm	1 box 5 blocks
	C14	12 x 14 x 18mm	
	C32	14 x 14 x 15mm	1 box 5 blocks
	C40	15 x 15 x 38 mm	
Shade	A1~A4 / B1~ B4 / C1 ~ C4 D1~D4 / W1~W4		
Flexure Strength (MPa)	250 Mpa (for milling)		
	450 Mpa (Final state)		
Indications	Inlay / Onlays / Veneers / Anterior Single crown / Posterior single crown / Max 3 unit / Max 5 unit		

### Representation of Natural Beauty

- Aesthetic values
- Structural stability
- Edge stability on NLD technology
- Multi-chromatic Gradation Effect

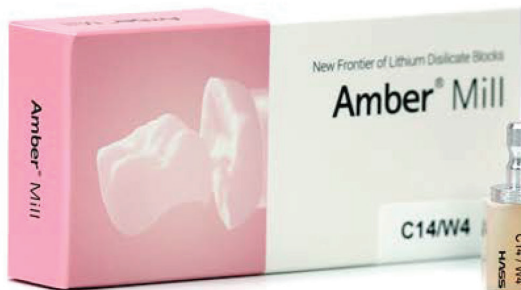

New Frontier of Lithium Disilicate-Based CAD/CAM blocks. Four different translucencies (HT, MT, LT, MO) in one block. Choose your own translucency just by changing crystallization temperature.

### Natural Opalescence & Fluorescence

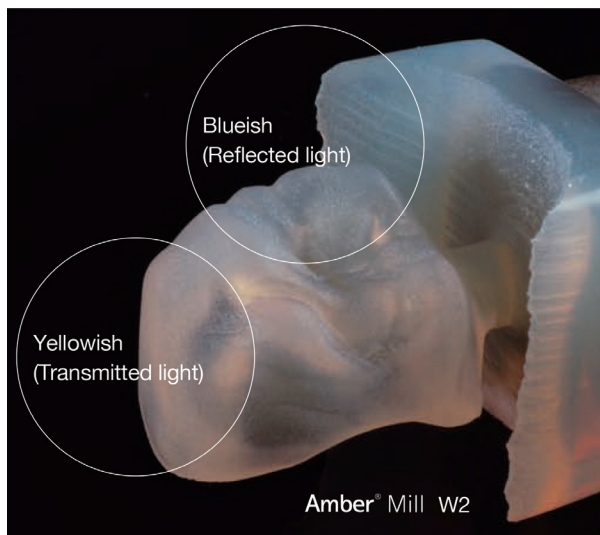

### Innovation That Works for You

#### Temperature

Low Temp. ————— High Temp.

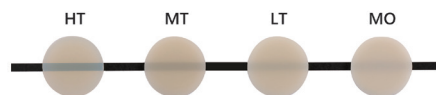

### Strength for Aesthetic Longevity

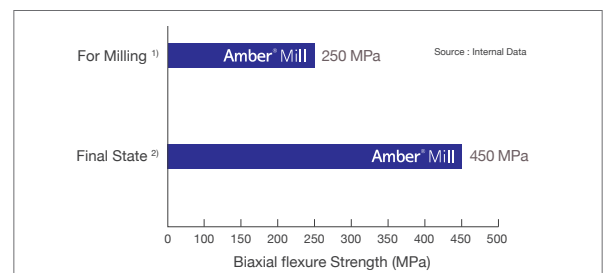

# Digital Material

## I. ZrGEN®

ZrGEN® is the brand name of MegaGen's Titanium Base. ZrGEN provides an aesthetic outcome and simplified dental implant prosthesis. A ZrGEN® crown and monolithic crown connected to a ZrGEN® Abutment provide strong and precise connection with the implant fixture.

### Variety of ZrGEN®



### ZrGEN® Sub Structure



### ZrGEN®

The strength of ZrGEN® frees you from the chipping of conventional PFM prosthesis. Monolithic zirconia crowns have no metal substructure, ensuring more aesthetic results. ZrGEN® crown and bridge are a superior substitutes for all conventional dental materials.

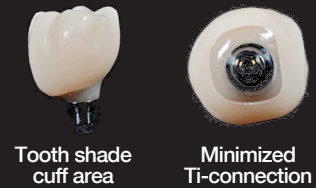

## II. TiGEN®

TiGEN® is the brand name of MegaGen's Pre-milled Abutment. It promises outstanding durability and simplified dental implant prosthesis. Ready-made connection part provides a strong and precise connection with the implant fixture.

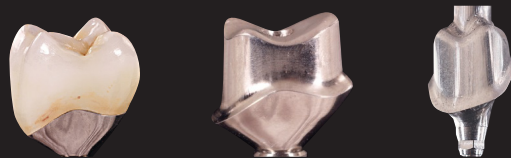

### Clinical Application



## ➔ Digital Prosthesis

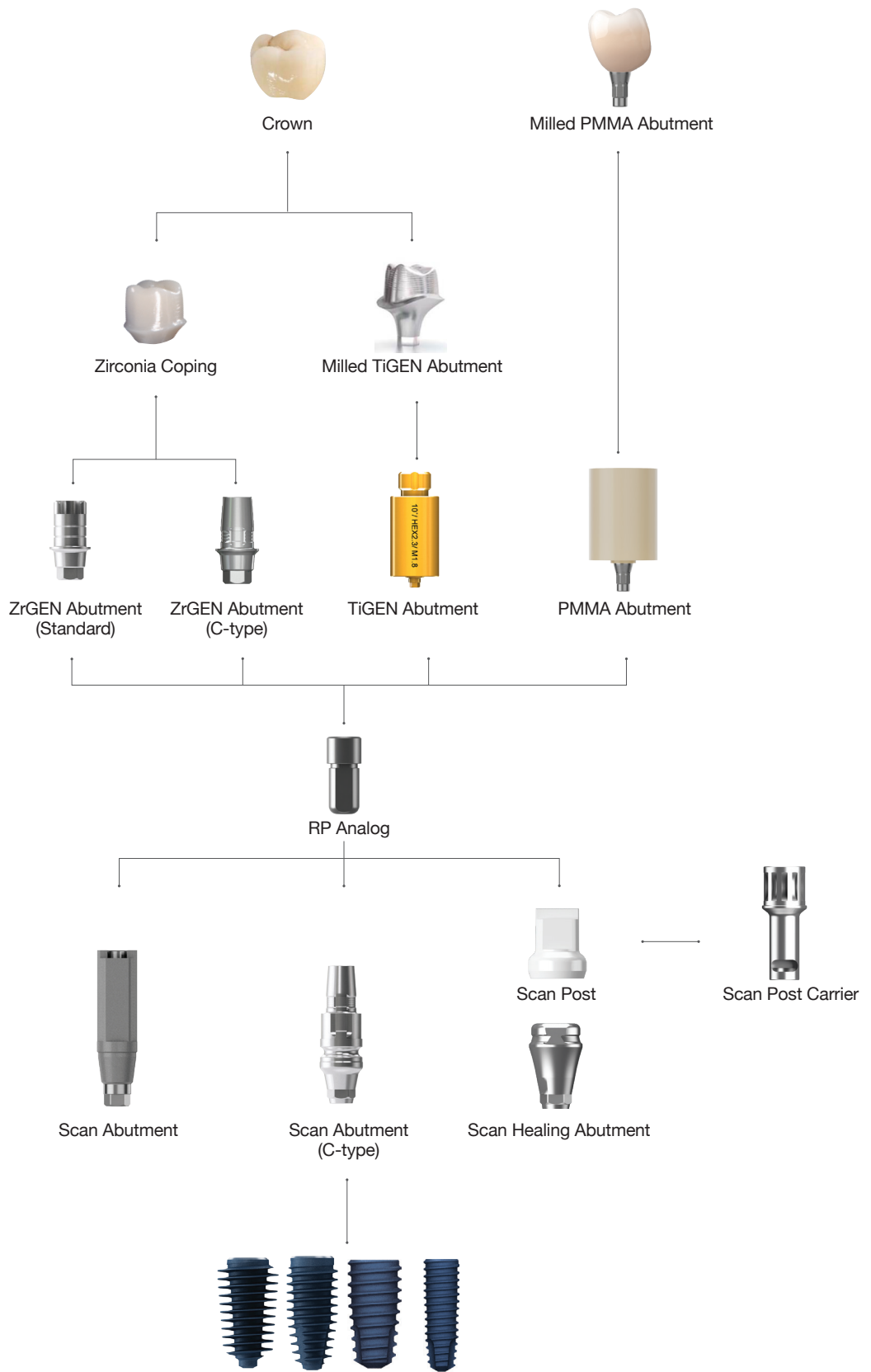

# ➔ Scan Abutment Option

## Scan Abutment

- Abutment Screw included.
  - ✓ AnyRidge (SAAANMSF)
  - ✓ BLUEDIAMOND NC (SAAROAS16B)
  - ✓ BLUEDIAMOND RC (SAAROAS16)
  - ✓ AnyOne Internal (SAAS20)
  - ✓ AnyOne External Small (SASCS160)
  - ✓ AnyOne External Regular (SARCS200)
  - ✓ AnyOne Onestage (SAEXIMS100)
  - ✓ MiNi (SAMIAS14)
  - ✓ ST Mini (SAOSGSAS3110)
  - ✓ ST Regular (SAOSGSAS3210)
  - ✓ Octa Level (SAIRCS200)
  - ✓ MUA Level (SAMUAS)
- For Chairside/ Labside
- Included spare Abutment Screw
- Supporting Dental CAD
  - 3Shape
  - exocad
  - Dental Wings
- Recommend torque : By Hand (5~8Ncm)

### Standard

System	Profile Diameter	Height (mm)	Ref.C	
AnyRidge	Ø4.0	9	AANISR4009T	
		13	AANISR4013T	
BLUEDIAMOND IMPLANT	Ø4.0	13	NC AROSANT	
			RC AROSART	
AnyOne Internal	Ø4.0	9	AAQISR4009T	
		13	AAQISR4013T	
AnyOne External	Ø4.0	9	AEXESS4009T	
		13	AEXESS4013T	
		9	AEXESR4009T	
		13	AEXESR4013T	
AnyOne Onestage	Ø4.0	10	AEXISR4010T	
MiNi	Ø3.5	9	MISS3509T	
		13	MISS3513T	
ST	Mini	Ø4.0	9	OSGSSC3110T
			13	OSGSSC3111T
	Regular	Ø4.0	9	OSGSSC3210T
			13	OSGSSC3211T
Octa Level	Ø4.0	11	AOCESC4011T	
MUA Level (N Type)	Ø4.0	13	AMUASR4013T	

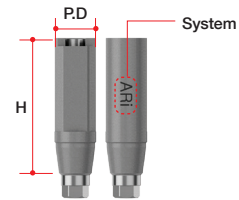

### C-type

- Abutment Screw included.
  - ✓ AnyRidge (SAAANMSF)
  - ✓ BLUEDIAMOND NC (SAAROAS16B)
  - ✓ BLUEDIAMOND RC (SAAROAS16)
  - ✓ AnyOne Internal (SAAS20)
- ScanPost for CEREC users.
- It is used when the exposure of the post part of ZrGEN Abutment (C-type) is small or when scanning is not easy due to the environment such as interference of surrounding teeth.
- Fasten by using Sirona Scanbody.
- In in Lab CAD Software, compatible with Xive Library.
- Recommend torque : By Hand (5~8Ncm)

System	Profile Diameter	Cuff Height (mm)	Connection	Ref.C		
AnyRidge	Ø3.9	0.5	S	ARICSS3405T		
		1		ARICSS3410T		
		2		ARICSS3420T		
	Ø4.3	0.5	S	ARICSS3805T		
		1		ARICSS3810T		
		2		ARICSS3820T		
	Ø5.5	0.5	L	ARICSL4505T		
		1		ARICSL4510T		
		2		ARICSL4520T		
	BLUEDIAMOND	Ø3.9	0.5	S	AROCSS3405NT	
			1		AROCSS3410NT	
			2		AROCSS3420NT	
0.5			AROCSS3805NT			
1			AROCSS3810NT			
2			AROCSS3820NT			
Ø4.3		0.5	S	AROCSS3405RT		
		1		AROCSS3410RT		
		2		AROCSS3420RT		
		0.5		AROCSS3805RT		
		1		AROCSS3810RT		
		2		AROCSS3820RT		
Ø5.5	0.5	L	AROCSL4505RT			
	1		AROCSL4510RT			
	2		AROCSL4520RT			
	AnyOne Internal		Ø3.9	0.5	S	AOICSS3405T
				1		AOICSS3410T
				2		AOICSS3420T
Ø4.3		0.5	S	AOICSS3805T		
		1		AOICSS3810T		
		2		AOICSS3820T		
Ø5.5	Ø5.5	0.5	L	AOICSL4505T		
		1		AOICSL4510T		
		2		AOICSL4520T		

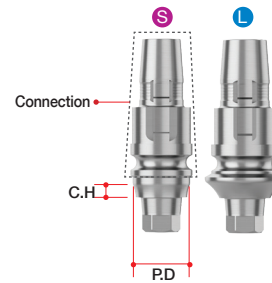

## Scan Healing Abutment

- Abutment Screw included.

- ✓ AnyRidge (ARIHS1804/ARIHS1805/ AR-IHS1807/ ARIHS1809)
- ✓ BLUEDIAMOND NC/ RC (AROHS1604/ AROHS1605/ AROHS1607/ AROHS1609)
- ✓ AnyOne Internal (AOIHS2004/AOIHS2005/ AOIHS2007/ AOIHS2009)
- ✓ ST Mini (STMHS1604/ STMHS1605/ ST-MHS1607/ STMHS1609)
- ✓ ST Regular (STRHS2004/ STRHS2005/ STRHS2007/ STMHS2009)

- Scannable Healing Abutment.
- For accurate scanning, Scan Healing Abutment must be exposed at least 2.0mm from surgical site.
- Recommend torque : By Hand (5~8Ncm)
- Height 9mm & ST system - FDA : Approved in 2023

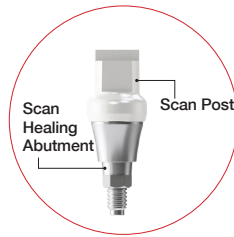

\* If Scan Healing Abutment is exposed more than 2.5mm, it may unbalance a fixture and results in fixture failure.

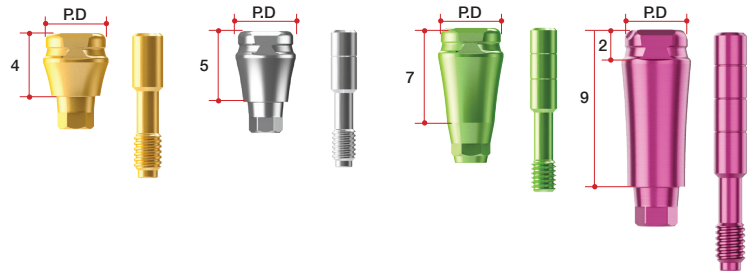

### Standard

System	Profile Diameter	Height (mm)	Ref.C
AnyRidge	Ø4.0	4	ARISH4004T
		5	ARISH4005T
		7	ARISH4007T
		9	ARISH4009T
	Ø5.0	4	ARISH5004T
		5	ARISH5005T
		7	ARISH5007T
		9	ARISH5009T
	Ø6.0	4	ARISH6004T
		5	ARISH6005T
		7	ARISH6007T
	Ø7.0	4	ARISH7004T
5		ARISH7005T	
7		ARISH7007T	
BLUE DIAMOND	Ø4.0	4	AROISHN4004T
		5	AROISHN4005T
		7	AROISHN4007T
		9	AROISHN4009T
	Ø5.0	4	AROISHN5004T
		5	AROISHN5005T
		7	AROISHN5007T
		9	AROISHN5009T
	Ø4.0	4	AROISHR4004T
		5	AROISHR4005T
		7	AROISHR4007T
		9	AROISHR4009T
		4	AROISHR5004T
		5	AROISHR5005T
		7	AROISHR5007T
		9	AROISHR5009T
		Ø6.0	4
	5		AROISHR6005T
	7		AROISHR6007T
	Ø7.0	4	AROISHR7004T
		5	AROISHR7005T
		7	AROISHR7007T
	Ø7.0	9	AROISHR7009T

System	Profile Diameter	Height (mm)	Ref.C	
AnyOne Internal	Ø4.0	4	AOISH4004T	
		5	AOISH4005T	
		7	AOISH4007T	
		9	AOISH4009T	
	Ø4.5	4	AOISH4504T	
		5	AOISH4505T	
		7	AOISH4507T	
		9	AOISH4509T	
	Ø5.5	4	AOISH5504T	
		5	AOISH5505T	
		7	AOISH5507T	
		9	AOISH5509T	
4		AOISH6504T		
Ø6.5	5	AOISH6505T		
	7	AOISH6507T		
	9	AOISH6509T		
	4	AOISH6509T		
ST	Mini	Ø4.0	4	STMHS4004T
		5	STMHS4005T	
		7	STMHS4007T	
		9	STMHS4009T	
	Regular	Ø5.0	4	STRSH5004T
			5	STRSH5005T
			7	STRSH5007T
			9	STRSH5009T
		Ø6.0	4	STRSH6004T
			5	STRSH6005T
			7	STRSH6007T
			9	STRSH6009T
			4	STRSH7004T
			5	STRSH7005T
			7	STRSH7007T
		Ø7.0	4	STRSH7004T
			5	STRSH7005T
			7	STRSH7007T
9	STRSH7009T			

### Extra

System	Fixture Core Diameter	Profile Diameter	Height (mm)	Ref.C	
AnyRidge	Ø3.3	Ø5.0	4	ARNSH5004T	
			5	ARNSH5005T	
			7	ARNSH5007T	
		Ø6.0	4	ARNSH6004T	
			5	ARNSH6005T	
			7	ARNSH6007T	
	Ø4.0	Ø6.0	4	ARNSH6009T	
			5	ARRSH6004T	
			7	ARRSH6005T	
		Ø6.0	4	ARRSH6007T	
			5	ARRSH6009T	
			7	ARRSH6009T	
		Ø7.0	Ø6.0	4	ARRSH7004T
				5	ARRSH7005T
				7	ARRSH7007T
			Ø7.0	4	ARRSH7004T
				5	ARRSH7005T
				7	ARRSH7007T
9	ARRSH7009T				

## Scan Post

- Scan Healing Abutment should be exposed 2.0mm from the surgical site for accurate scanning. Scanning would be much easier if you connect Scan Post when scanning seems difficult due to less exposure of Scan Healing Abutment or other conditions.
- Select Scan Post based on the diameter of Scan Healing Abutment
  - \* AnyOne Internal Profile Diameter
    - Ø4.0 → Ø4.0
    - Ø4.5 → Ø5.0
    - Ø5.5 → Ø6.0
    - Ø6.5 → Ø7.0
- Scan Post is a disposable product.
- 1 set consists of 10 Scan Posts.

Profile Diameter	Height (mm)	Ref.C
Ø4.0	6.5	SP4007.MTN
Ø5.0		SP5007.MTN
Ø6.0		SP6007.MTN
Ø7.0		SP7007.MTN



## Scan Post Carrier

Profile Diameter	Height (mm)	Ref.C
Ø5	19	SPC16

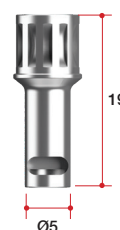

## ➔ RP Analog Option

### RP Analog

- For Chairside/ Labside
- Supporting Dental CAD
  - 3Shape
  - exocad

System	Profile Diameter	Height (mm)	System
AnyRidge	Ø4.0	9	CANIAR4009
BLUE DIAMOND	NC Ø3.3	10	AROLAN
	RC Ø4.1		AROLAR
AnyOne Internal	Only Ø3.5	9	CAOIAS3509
	-		CAOJAR4009
AnyOne External	S Ø3.5	9	CEXEAS3509
	R Ø4.1		CEXEAR4109
	W Ø5.0		CEXEAW5009
AnyOne Onestage	Ø4.8	9	OSRA18
MiNi	Ø3.0	9	CMIIAN3009
ST	Mini Ø3.7	9	OSRA3709
	Regular Ø4.3		OSRA4309
Octa Level	Small Ø3.8	9	OCTARA4
	Regular Ø4.8		OCTARA5
	Wide Ø5.8		OCTARA6
MUA Level (N Type)	Ø4.8	9	MUALA

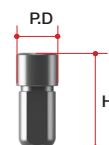

## ➔ PMMA Abutment Option (Continued)

**NEW**

### PMMA Abutment

(Comming soon)

- Abutment Screw included.
- ✓ AnyRidge (AANMSF)
- ✓ BLUEDIAMOND NC (AROAS16B)
- ✓ BLUEDIAMOND RC (AROAS16)
- ✓ AnyOne Internal (AS20)
- ✓ ST Mini (OSGSAS3110)
- Pre-milled Abutment
  - Pre-milled part : Implant Connection + Cuff (0.6/ 1.5/ 3.0mm)
- 1 Set consists of 10 Abutments
  - included spare Abutment Screw
- Supporting Dental CAD
  - 3 Shape
  - exocad
- Supporting Milling Machine
  - MegaGen Implant : BX5
  - ARUM DENTISTRY
- Recommend torque
  - 25Ncm : AnyRidge/ BLUEDIAMOND/ AnyOne Internal
  - 20Ncm : ST (Mini)

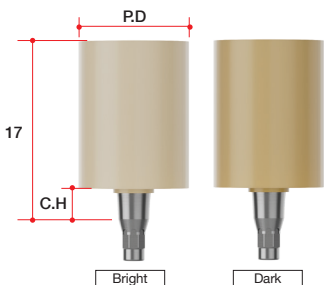

System	Color	Profile Diameter	Cuff Height (mm)	Length (mm)	Type	Ref.C				
AnyRidge	Bright	Ø8	0.6	17	Hex	ARPA0608B.MTN				
			1.5			ARPA1508B.MTN				
			3.0			ARPA3008B.MTN				
		Ø12	0.6			ARPA0612B.MTN				
			1.5			ARPA1512B.MTN				
			3.0			ARPA3012B.MTN				
		Ø16	0.6			ARPA0616B.MTN				
			1.5			ARPA1516B.MTN				
			3.0			ARPA3016B.MTN				
		Dark	Ø8			0.6	ARPA0608D.MTN			
						1.5	ARPA1508D.MTN			
						3.0	ARPA3008D.MTN			
	Ø12		0.6			ARPA0612D.MTN				
			1.5			ARPA1512D.MTN				
			3.0			ARPA3012D.MTN				
	Ø16		0.6			ARPA0616D.MTN				
			1.5			ARPA1516D.MTN				
			3.0			ARPA3016D.MTN				
	BLUEDIAMOND		Bright			Ø8	0.6	17	Octa	BDPAN0608B.MTN
							1.5			BDPAN1508B.MTN
							3.0			BDPAN3008B.MTN
		Ø12				0.6	BDPAN0612B.MTN			
						1.5	BDPAN1512B.MTN			
						3.0	BDPAN3012B.MTN			
Ø16		0.6		BDPAN0616B.MTN						
		1.5		BDPAN1516B.MTN						
		3.0		BDPAN3016B.MTN						
Dark		Ø8		0.6	BDPAN0608D.MTN					
				1.5	BDPAN1508D.MTN					
				3.0	BDPAN3008D.MTN					
		Ø12	0.6	BDPAN0612D.MTN						
			1.5	BDPAN1512D.MTN						
			3.0	BDPAN3012D.MTN						
		Ø16	0.6	BDPAN0616D.MTN						
			1.5	BDPAN1516D.MTN						
			3.0	BDPAN3016D.MTN						
		BLUEDIAMOND	Bright	Ø8	0.6	17	Octa			BDFPAR0608B.MTN
					1.5					BDFPAR1508B.MTN
					3.0					BDFPAR3008B.MTN
Ø12				0.6	BDFPAR0612B.MTN					
				1.5	BDFPAR1512B.MTN					
				3.0	BDFPAR3012B.MTN					
Ø16	0.6			BDFPAR0616B.MTN						
	1.5			BDFPAR1516B.MTN						
	3.0			BDFPAR3016B.MTN						
Dark	Ø8			0.6	BDFPAR0608D.MTN					
				1.5	BDFPAR1508D.MTN					
				3.0	BDFPAR3008D.MTN					
	Ø12		0.6	BDFPAR0612D.MTN						
			1.5	BDFPAR1512D.MTN						
			3.0	BDFPAR3012D.MTN						
	Ø16		0.6	BDFPAR0616D.MTN						
			1.5	BDFPAR1516D.MTN						
			3.0	BDFPAR3016D.MTN						

## ➔ PMMA Abutment Option

[PMMA Abutment Line-Up]

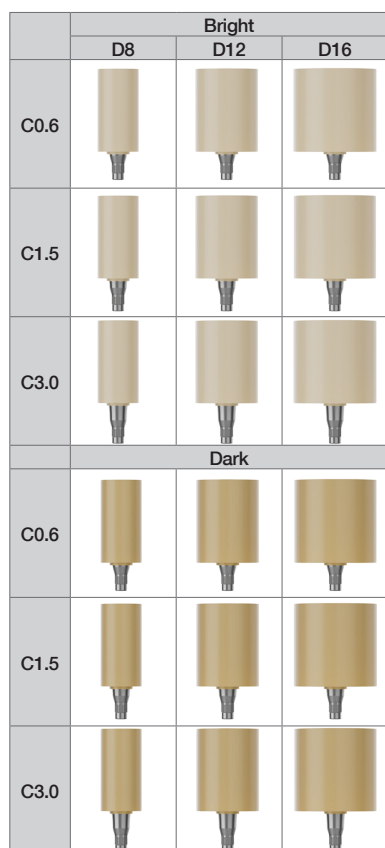

System	Color	Profile Diameter	Cuff Height (mm)	Length (mm)	Type	Ref.C
AnyOne Internal	Bright	Ø8	0.6	17	Hex	AOPA0608B.MTN
			1.5			AOPA1508B.MTN
			3.0			AOPA3016B.MTN
		Ø12	0.6			AOPA0612B.MTN
			1.5			AOPA1512B.MTN
			3.0			AOPA3012B.MTN
		Ø16	0.6			AOPA0616B.MTN
			1.5			AOPA1516B.MTN
			3.0			AOPA3016B.MTN
	Dark	Ø8	0.6			AOPA0608D.MTN
			1.5			AOPA1508D.MTN
			3.0			AOPA3008D.MTN
		Ø12	0.6			AOPA0612D.MTN
			1.5			AOPA1512D.MTN
			3.0			AOPA3012D.MTN
		Ø16	0.6			AOPA0616D.MTN
			1.5			AOPA1516D.MTN
			3.0			AOPA3016D.MTN
ST	Mini	Ø8	0.6	17	Hex	STPAM0608B.MTN
			1.5			STPAM1508B.MTN
			3.0			STPAM3008B.MTN
		Ø12	0.6			STPAM0612B.MTN
			1.5			STPAM1512B.MTN
			3.0			STPAM3012B.MTN
		Ø16	0.6			STPAM0616B.MTN
			1.5			STPAM1516B.MTN
			3.0			STPAM3016B.MTN
	Dark	Ø8	0.6			STPAM0608D.MTN
			1.5			STPAM1508D.MTN
			3.0			STPAM3008D.MTN
		Ø12	0.6			STPAM0612D.MTN
			1.5			STPAM1512D.MTN
			3.0			STPAM3012D.MTN
		Ø16	0.6			STPAM0616D.MTN
			1.5			STPAM1516D.MTN
			3.0			STPAM3016D.MTN

► PMMA Abutment have same form of cuff shape as the Scan Healing Abutment thus custom abutment with perfectly fit to emergence profile can be fabricated

· Various cuff sizes for various gingival heights

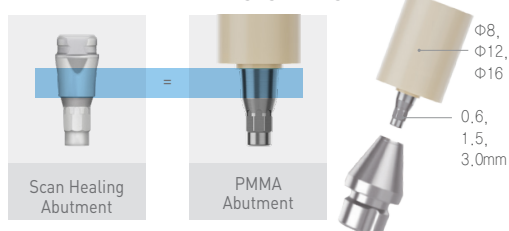

► Integrated Ti-base & PMMA

- No inner crown surface milling, reducing processing time by 30%
- No cement work between Ti-base & crown
- 50% reduction in processing time!



## ➔ ZrGEN Abutment Option (Continued)

### ZrGEN Abutment

**- Abutment Screw included.**

- ✓ AnyRidge (AANMSF)
- ✓ BLUEDIAMOND NC (AROAS16B)
- ✓ BLUEDIAMOND RC (AROAS16)
- ✓ AnyOne Internal (AS20)
- ✓ AnyOne External Small (SCS160)
- ✓ AnyOne External Regular/ Wide (RCS200)
- ✓ AnyOne Onestage (EXIMS100)
- ✓ MiNi (MAZ1410)
- ✓ ST Mini (OSGSAS3110)
- ✓ ST Regular (OSGSAS3210)
- ✓ Octa Level (IRCS200)
- ✓ MUA Level (MUAS)

- MiNi ZrGEN has special abutment screw (Available only in ZrGEN Abutment)
- Supporting DentalCAD
  - 3 Shape
  - Exocad
  - Dental Wing
- Post Height can be checked by the number of Groove.
  - Post Height : 4.5mm → Groove : 2ea
  - Post Height : 5mm → Groove : 3ea
  - Post Height : 6mm → Groove : 4ea
  - Post Height : 8mm → Groove : 6ea
- Recommend torque
  - 35Ncm : AnyRidge/ BLUEDIAMOND/ AnyOne Internal / AnyOne External (Regular & Wide)/ AnyOne Onestage/ Octa Level
  - 30Ncm : ST (Regular)
  - 25Ncm : AnyOne External (Small)
  - 20Ncm : ST (Mini)
  - 15Ncm : MiNi/ MUA Level

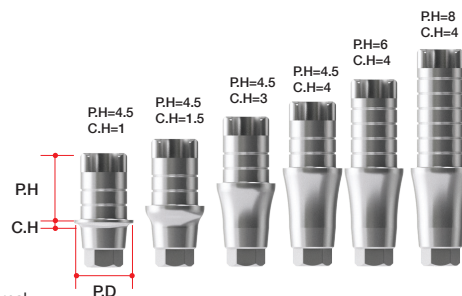

- Titanium Base
- 1 set consists of 10 Abutments.
  - included spare Abutment Screw

### Standard

System	Profile Diameter	Cuff Height (mm)	Post Height (mm)	Type	Ref.C	
AnyRidge	Ø4.0	0.6	4.5	Hex	AANIPR4015.MTN	
			6		AANIPR4016.MTN	
			8		AANIPR4018.MTN	
		1.5	4.5		AANIPR4025.MTN	
			6		AANIPR4026.MTN	
			8		AANIPR4028.MTN	
		3.0	4.5		AANIPR4035.MTN	
			6		AANIPR4036.MTN	
			8		AANIPR4038.MTN	
		4.0	4.5		AANIPR4045.MTN	
			6		AANIPR4046.MTN	
			8		AANIPR4048.MTN	
		Ø4.5	Hex	0.6	4.5	AANIPR4015N.MTN
					6	AANIPR4016N.MTN
					8	AANIPR4018N.MTN
				1.5	4.5	AANIPR4025N.MTN
					6	AANIPR4026N.MTN
					8	AANIPR4028N.MTN
				3.0	4.5	AANIPR4035N.MTN
					6	AANIPR4036N.MTN
					8	AANIPR4038N.MTN
				4.0	4.5	AANIPR4045N.MTN
					6	AANIPR4046N.MTN
					8	AANIPR4048N.MTN
	Non-Hex		0.6	4.5	AANIPR4515.MTN	
				6	AANIPR4516.MTN	
				8	AANIPR4518.MTN	
			1.5	4.5	AANIPR4525.MTN	
				6	AANIPR4526.MTN	
				8	AANIPR4528.MTN	
			3.0	4.5	AANIPR4535.MTN	
				6	AANIPR4536.MTN	
				8	AANIPR4538.MTN	
			4.0	4.5	AANIPR4545.MTN	
				6	AANIPR4546.MTN	
				8	AANIPR4548.MTN	
	Non-Hex	0.6	4.5	AANIPR4515N.MTN		
			6	AANIPR4516N.MTN		
			8	AANIPR4518N.MTN		
		1.5	4.5	AANIPR4525N.MTN		
			6	AANIPR4526N.MTN		
			8	AANIPR4528N.MTN		
		3.0	4.5	AANIPR4535N.MTN		
			6	AANIPR4536N.MTN		
			8	AANIPR4538N.MTN		
		4.0	4.5	AANIPR4545N.MTN		
			6	AANIPR4546N.MTN		
			8	AANIPR4548N.MTN		

System	Profile Diameter	Cuff Height (mm)	Post Height (mm)	Type	Ref.C
BLUEDIAMOND	NC	Ø4.0	0.6	Octa	AROZGN4015.MTN
			1.5		AROZGN4025.MTN
			4.5		AROZGN4035.MTN
		6.0	4.0		AROZGN4045.MTN
			0.6		AROZGN4016.MTN
			1.5		AROZGN4026.MTN
	RC	Ø4.5	3.0	Octa	AROZGN4036.MTN
			4.0		AROZGN4046.MTN
			8.0		AROZGN4018.MTN
		8.0	0.6		AROZGN4028.MTN
			1.5		AROZGN4038.MTN
			4.0		AROZGN4048.MTN
BLUEDIAMOND	RC	Ø4.5	0.6	Octa	AROZGR4515.MTN
			1.5		AROZGR4525.MTN
			4.5		AROZGR4535.MTN
		6.0	0.6		AROZGR4545.MTN
			1.5		AROZGR4526.MTN
			3.0		AROZGR4536.MTN
	RC	Ø4.5	4.0	Octa	AROZGR4546.MTN
			8.0		AROZGR4518.MTN
			0.6		AROZGR4528.MTN
		8.0	1.5		AROZGR4538.MTN
			3.0		AROZGR4538.MTN
			4.0		AROZGR4548.MTN

## ➔ ZrGEN Abutment Option (Continued)

### Standard

System	Profile Diameter	Cuff Height (mm)	Post Height (mm)	Type	Ref.C	
AnyOne Internal	Ø4.0	0.6	4.5	Hex	AAOIPR4015.MTN	
			6		AAOIPR4016.MTN	
			8		AAOIPR4018.MTN	
		1.5	4.5		AAOIPR4025.MTN	
			6		AAOIPR4026.MTN	
			8		AAOIPR4028.MTN	
		3.0	4.5		AAOIPR4035.MTN	
			6		AAOIPR4036.MTN	
			8		AAOIPR4038.MTN	
		4.0	4.5		AAOIPR4045.MTN	
			6		AAOIPR4046.MTN	
			8		AAOIPR4048.MTN	
		Ø4.5	0.6	4.5	Non-Hex	AAOIPR4015N.MTN
				6		AAOIPR4016N.MTN
				8		AAOIPR4018N.MTN
			1.5	4.5		AAOIPR4025N.MTN
				6		AAOIPR4026N.MTN
				8		AAOIPR4028N.MTN
			3.0	4.5		AAOIPR4035N.MTN
				6		AAOIPR4036N.MTN
				8		AAOIPR4038N.MTN
			4.0	4.5		AAOIPR4045N.MTN
				6		AAOIPR4046N.MTN
				8		AAOIPR4048N.MTN
	Ø4.5		0.6	4.5	Hex	AAOIPR4515.MTN
				6		AAOIPR4516.MTN
				8		AAOIPR4518.MTN
			1.5	4.5		AAOIPR4525.MTN
				6		AAOIPR4526.MTN
				8		AAOIPR4528.MTN
			3.0	4.5		AAOIPR4535.MTN
				6		AAOIPR4536.MTN
				8		AAOIPR4538.MTN
			4.0	4.5		AAOIPR4545.MTN
				6		AAOIPR4546.MTN
				8		AAOIPR4548.MTN
		Ø4.5	0.6	4.5	Non-Hex	AAOIPR4515N.MTN
				6		AAOIPR4516N.MTN
				8		AAOIPR4518N.MTN
			1.5	4.5		AAOIPR4525N.MTN
				6		AAOIPR4526N.MTN
				8		AAOIPR4528N.MTN
			3.0	4.5		AAOIPR4535N.MTN
				6		AAOIPR4536N.MTN
				8		AAOIPR4538N.MTN
			4.0	4.5		AAOIPR4545N.MTN
				6		AAOIPR4546N.MTN
				8		AAOIPR4548N.MTN

System	Profile Diameter	Cuff Height (mm)	Post Height (mm)	Type	Ref.C	
AnyOne External	Ø4.2	0.6	4.5	Hex	AEXEPS4015.MTN	
			6		AEXEPS4016.MTN	
			8		AEXEPS4018.MTN	
		1.5	4.5		AEXEPS4025.MTN	
			6		AEXEPS4026.MTN	
			8		AEXEPS4028.MTN	
		3.0	4.5		AEXEPS4035.MTN	
			6		AEXEPS4036.MTN	
			8		AEXEPS4038.MTN	
		4.0	4.5		AEXEPS4045.MTN	
			6		AEXEPS4046.MTN	
			8		AEXEPS4048.MTN	
		Ø4.5	0.6	4.5	Hex	AEXEPS4515.MTN
				6		AEXEPS4516.MTN
				8		AEXEPS4518.MTN
			1.5	4.5		AEXEPS4525.MTN
				6		AEXEPS4526.MTN
				8		AEXEPS4528.MTN
			3.0	4.5		AEXEPS4535.MTN
				6		AEXEPS4536.MTN
				8		AEXEPS4538.MTN
			4.0	4.5		AEXEPS4545.MTN
				6		AEXEPS4546.MTN
				8		AEXEPS4548.MTN
	Ø4.5		0.6	4.5	Non-Hex	AEXEPR4515.MTN
				6		AEXEPR4516.MTN
				8		AEXEPR4518.MTN
			1.5	4.5		AEXEPR4525.MTN
				6		AEXEPR4526.MTN
				8		AEXEPR4528.MTN
			3.0	4.5		AEXEPR4535.MTN
				6		AEXEPR4536.MTN
				8		AEXEPR4538.MTN
			4.0	4.5		AEXEPR4545.MTN
				6		AEXEPR4546.MTN
				8		AEXEPR4548.MTN
	Ø4.5	0.6	4.5	Hex	AEXEPW5515.MTN	
			6		AEXEPW5516.MTN	
			8		AEXEPW5518.MTN	
		1.5	4.5		AEXEPW5525.MTN	
			6		AEXEPW5526.MTN	
			8		AEXEPW5528.MTN	
		3.0	4.5		AEXEPW5535.MTN	
			6		AEXEPW5536.MTN	
			8		AEXEPW5538.MTN	
		4.0	4.5		AEXEPW5545.MTN	
			6		AEXEPW5546.MTN	
			8		AEXEPW5548.MTN	
Ø4.8		0.6	4.5	Octa	AEXIPR5015.MTN	
			6		AEXIPR5016.MTN	
			8		AEXIPR5018.MTN	
		1.5	4.5		AEXIPR5025.MTN	
			6		AEXIPR5026.MTN	
			8		AEXIPR5028.MTN	
		3.0	4.5		AEXIPR5035.MTN	
			6		AEXIPR5036.MTN	
			8		AEXIPR5038.MTN	
		4.0	4.5		AEXIPR5045.MTN	
			6		AEXIPR5046.MTN	
			8		AEXIPR5048.MTN	

Standard

System	Profile Diameter	Cuff Height (mm)	Post Height (mm)	Type	Ref.C	
Mini	Ø3.0	0.6	2.5	Hex	MIPN3013.MTN	
			2.5	Non-Hex	MIPN3013N.MTN	
Mini	Ø4.0	0.6	4.5	Hex	OSGSPA3111.MTN	
			6		OSGSPA3112.MTN	
			8		OSGSPA3113.MTN	
			4.5		OSGSPA3121.MTN	
			6		OSGSPA3122.MTN	
			8		OSGSPA3123.MTN	
		1.5	4.5	6	Hex	OSGSPA3131.MTN
				8		OSGSPA3132.MTN
				8		OSGSPA3133.MTN
				4.5		OSGSPA3141.MTN
				6		OSGSPA3142.MTN
				8		OSGSPA3143.MTN
		3.0	4.5	6	Non-Hex	OSGSPA3111N.MTN
				8		OSGSPA3112N.MTN
				8		OSGSPA3113N.MTN
				4.5		OSGSPA3121N.MTN
				6		OSGSPA3122N.MTN
				8		OSGSPA3123N.MTN
		4.0	4.5	6	Non-Hex	OSGSPA3131N.MTN
				8		OSGSPA3132N.MTN
				8		OSGSPA3133N.MTN
				4.5		OSGSPA3141N.MTN
				6		OSGSPA3142N.MTN
				8		OSGSPA3143N.MTN
ST	Ø4.0	0.6	4.5	Hex	OSGSPA3211.MTN	
			6		OSGSPA3212.MTN	
			8		OSGSPA4018.MTN	
			4.5		OSGSPA4025.MTN	
			6		OSGSPA4026.MTN	
			8		OSGSPA4028.MTN	
		1.5	4.5	6	Hex	OSGSPA4035.MTN
				8		OSGSPA4036.MTN
				8		OSGSPA4038.MTN
				4.5		OSGSPA4045.MTN
				6		OSGSPA4046.MTN
				8		OSGSPA4048.MTN
		3.0	4.5	6	Non-Hex	OSGSPA3211N.MTN
				8		OSGSPA3212N.MTN
				8		OSGSPA4018N.MTN
				4.5		OSGSPA4025N.MTN
				6		OSGSPA4026N.MTN
				8		OSGSPA4028N.MTN
		4.0	4.5	6	Non-Hex	OSGSPA4035N.MTN
				8		OSGSPA4036N.MTN
				8		OSGSPA4038N.MTN
				4.5		OSGSPA4045N.MTN
				6		OSGSPA4046N.MTN
				8		OSGSPA4048N.MTN
Regular	Ø4.5	0.6	4.5	Hex	OSGSPA4515.MTN	
			6		OSGSPA4516.MTN	
			8		OSGSPA4518.MTN	
			4.5		OSGSPA3221.MTN	
			6		OSGSPA3222.MTN	
			8		OSGSPA4528.MTN	
		1.5	4.5	6	Hex	OSGSPA4535.MTN
				8		OSGSPA4536.MTN
				8		OSGSPA4538.MTN
				4.5		OSGSPA4545.MTN
				6		OSGSPA4546.MTN
				8		OSGSPA4548.MTN
		3.0	4.5	6	Non-Hex	OSGSPA4515N.MTN
				8		OSGSPA4516N.MTN
				8		OSGSPA4518N.MTN
				4.5		OSGSPA3221N.MTN
				6		OSGSPA3222N.MTN
				8		OSGSPA4528N.MTN
		4.0	4.5	6	Non-Hex	OSGSPA4535N.MTN
				8		OSGSPA4536N.MTN
				8		OSGSPA4538N.MTN
				4.5		OSGSPA4545N.MTN
				6		OSGSPA4546N.MTN
				8		OSGSPA4548N.MTN

System	Profile Diameter	Cuff Height (mm)	Post Height (mm)	Type	Ref.C	
Octa Level	Small	Ø5.0	0.8	5	Octa	AOCEPS5015.MTN
				6		AOCEPS5016.MTN
				8		AOCEPS5018.MTN
			0.8	Non-Octa	5	ANOEPS5015.MTN
					6	ANOEPS5016.MTN
					8	ANOEPS5018.MTN
	Regular	Ø5.5	0.8	5	Octa	AOCEPR5515.MTN
				6		AOCEPR5516.MTN
				8		AOCEPR5518.MTN
			0.8	Non-Octa	5	ANOEPR5515.MTN
					6	ANOEPR5516.MTN
					8	ANOEPR5518.MTN
Wide	Ø6.5	0.8	5	Octa	AOCEPW6515.MTN	
			6		AOCEPW6516.MTN	
			8		AOCEPW6518.MTN	
		0.8	Non-Octa	5	ANOEPW6515.MTN	
				6	ANOEPW6516.MTN	
				8	ANOEPW6518.MTN	
MUA Level	Ø5.5	0.8	5	N Type	AMUAPR5515N.MTN	
			6		AMUAPR5516N.MTN	
			8		AMUAPR5518N.MTN	

# ➔ ZrGEN Abutment Option (Continued)

Extra

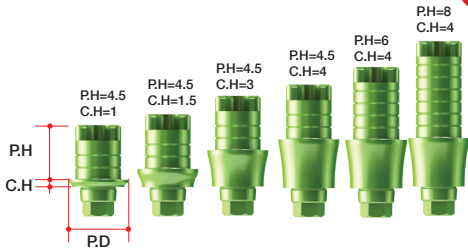

System	Fixture Core Diameter	Profile Diameter	Cuff Height (mm)	Post Height (mm)	Type	Ref.C				
AnyRidge	Ø3.3	Ø4.5	0.6	4.5	Hex	ARZXM4515.MTN				
				6		ARZXM4516.MTN				
				8		ARZXM4518.MTN				
			1.5	4.5		Hex	ARZXM4525.MTN			
				6			ARZXM4526.MTN			
				8			ARZXM4528.MTN			
			3.0	4.5			Hex	ARZXM4535.MTN		
				6				ARZXM4536.MTN		
				8				ARZXM4538.MTN		
			4.0	4.5	Hex			ARZXM4545.MTN		
				6				ARZXM4546.MTN		
				8				ARZXM4548.MTN		
			Non-Hex	0.6		4.5		Non-Hex	ARZXM4515N.MTN	
						6			ARZXM4516N.MTN	
						8			ARZXM4518N.MTN	
				1.5		4.5	Non-Hex		ARZXM4525N.MTN	
						6			ARZXM4526N.MTN	
						8			ARZXM4528N.MTN	
				3.0	4.5	Non-Hex			ARZXM4535N.MTN	
					6				ARZXM4536N.MTN	
					8				ARZXM4538N.MTN	
				4.0	4.5				Non-Hex	ARZXM4545N.MTN
					6					ARZXM4546N.MTN
					8					ARZXM4548N.MTN
	Ø3.8	Ø5.0	0.6	4.5	Hex			ARZXM503815.MTN		
				6				ARZXM503816.MTN		
				8				ARZXM503818.MTN		
			1.5	4.5			Hex	ARZXM503825.MTN		
				6				ARZXM503826.MTN		
				8				ARZXM503828.MTN		
			3.0	4.5		Hex		ARZXM503835.MTN		
				6				ARZXM503836.MTN		
				8				ARZXM503838.MTN		
			4.0	4.5	Hex			ARZXM503845.MTN		
				6				ARZXM503846.MTN		
				8				ARZXM503848.MTN		
		Non-Hex	0.6	4.5			Non-Hex	ARZXM503815N.MTN		
				6				ARZXM503816N.MTN		
				8				ARZXM503818N.MTN		
			1.5	4.5		Non-Hex		ARZXM503825N.MTN		
				6				ARZXM503826N.MTN		
				8				ARZXM503828N.MTN		
			3.0	4.5	Non-Hex			ARZXM503835N.MTN		
				6				ARZXM503836N.MTN		
				8				ARZXM503838N.MTN		
			4.0	4.5				Non-Hex	ARZXM503845N.MTN	
				6					ARZXM503846N.MTN	
				8					ARZXM503848N.MTN	
Ø5.5	Hex	0.6	4.5	Hex			ARZXM553815.MTN			
			6				ARZXM553816.MTN			
			8				ARZXM553818.MTN			
		1.5	4.5			Hex	ARZXM553825.MTN			
			6				ARZXM553826.MTN			
			8				ARZXM553828.MTN			
	3.0	4.5	Hex		ARZXM553835.MTN					
		6			ARZXM553836.MTN					
		8			ARZXM553838.MTN					
	4.0	4.5			Hex		ARZXM553845.MTN			
		6					ARZXM553846.MTN			
		8					ARZXM553848.MTN			
Non-Hex	0.6	4.5		Non-Hex			ARZXM553815N.MTN			
		6					ARZXM553816N.MTN			
		8					ARZXM553818N.MTN			
	1.5	4.5				Non-Hex	ARZXM553825N.MTN			
		6					ARZXM553826N.MTN			
		8					ARZXM553828N.MTN			
3.0	4.5	Non-Hex	ARZXM553835N.MTN							
	6		ARZXM553836N.MTN							
	8		ARZXM553838N.MTN							
4.0	4.5		Non-Hex		ARZXM553845N.MTN					
	6				ARZXM553846N.MTN					
	8				ARZXM553848N.MTN					

Extra

System	Fixture Core Diameter	Profile Diameter	Cuff Height (mm)	Post Height (mm)	Type	Ref.C
AnyRidge	Ø4.0	Ø5.0	0.6	4.5	Hex	ARZXM5015.MTN
				6		ARZXM5016.MTN
				8		ARZXM5018.MTN
			1.5	4.5		ARZXM5025.MTN
				6		ARZXM5026.MTN
				8		ARZXM5028.MTN
			3.0	4.5		ARZXM5035.MTN
				6		ARZXM5036.MTN
				8		ARZXM5038.MTN
			4.0	4.5		ARZXM5045.MTN
				6		ARZXM5046.MTN
				8		ARZXM5048.MTN
		Ø5.5	0.6	4.5	Non-Hex	ARZXM5015N.MTN
				6		ARZXM5016N.MTN
				8		ARZXM5018N.MTN
			1.5	4.5		ARZXM5025N.MTN
				6		ARZXM5026N.MTN
				8		ARZXM5028N.MTN
			3.0	4.5		ARZXM5035N.MTN
				6		ARZXM5036N.MTN
				8		ARZXM5038N.MTN
			4.0	4.5		ARZXM5045N.MTN
				6		ARZXM5046N.MTN
				8		ARZXM5048N.MTN
	Ø5.5	Hex	0.6	4.5	ARZXM5515.MTN	
				6	ARZXM5516.MTN	
				8	ARZXM5518.MTN	
			1.5	4.5	ARZXM5525.MTN	
				6	ARZXM5526.MTN	
				8	ARZXM5528.MTN	
			3.0	4.5	ARZXM5535.MTN	
				6	ARZXM5536.MTN	
				8	ARZXM5538.MTN	
			4.0	4.5	ARZXM5545.MTN	
				6	ARZXM5546.MTN	
				8	ARZXM5548.MTN	
		Non-Hex	0.6	4.5	ARZXM5515N.MTN	
				6	ARZXM5516N.MTN	
				8	ARZXM5518N.MTN	
			1.5	4.5	ARZXM5525N.MTN	
				6	ARZXM5526N.MTN	
				8	ARZXM5528N.MTN	
			3.0	4.5	ARZXM5535N.MTN	
				6	ARZXM5536N.MTN	
				8	ARZXM5538N.MTN	
			4.0	4.5	ARZXM5545N.MTN	
				6	ARZXM5546N.MTN	
				8	ARZXM5548N.MTN	

System	Fixture Core Diameter	Profile Diameter	Cuff Height (mm)	Post Height (mm)	Type	Ref.C
AnyRidge	Ø4.8	Ø5.5	0.6	4.5	Hex	ARZXL5515.MTN
				6		ARZXL5516.MTN
				8		ARZXL5518.MTN
			1.5	4.5		ARZXL5525.MTN
				6		ARZXL5526.MTN
				8		ARZXL5528.MTN
			3.0	4.5		ARZXL5535.MTN
				6		ARZXL5536.MTN
				8		ARZXL5538.MTN
			4.0	4.5		ARZXL5545.MTN
				6		ARZXL5546.MTN
				8		ARZXL5548.MTN
		Ø6.0	0.6	4.5	Non-Hex	ARZXL5515N.MTN
				6		ARZXL5516N.MTN
				8		ARZXL5518N.MTN
			1.5	4.5		ARZXL5525N.MTN
				6		ARZXL5526N.MTN
				8		ARZXL5528N.MTN
			3.0	4.5		ARZXL5535N.MTN
				6		ARZXL5536N.MTN
				8		ARZXL5538N.MTN
			4.0	4.5		ARZXL5545N.MTN
				6		ARZXL5546N.MTN
				8		ARZXL5548N.MTN
	Ø6.0	Hex	0.6	4.5	ARZXL6015.MTN	
				6	ARZXL6016.MTN	
				8	ARZXL6018.MTN	
			1.5	4.5	ARZXL6025.MTN	
				6	ARZXL6026.MTN	
				8	ARZXL6028.MTN	
			3.0	4.5	ARZXL6035.MTN	
				6	ARZXL6036.MTN	
				8	ARZXL6038.MTN	
			4.0	4.5	ARZXL6045.MTN	
				6	ARZXL6046.MTN	
				8	ARZXL6048.MTN	
		Non-Hex	0.6	4.5	ARZXL6015N.MTN	
				6	ARZXL6016N.MTN	
				8	ARZXL6018N.MTN	
			1.5	4.5	ARZXL6025N.MTN	
				6	ARZXL6026N.MTN	
				8	ARZXL6028N.MTN	
			3.0	4.5	ARZXL6035N.MTN	
				6	ARZXL6036N.MTN	
				8	ARZXL6038N.MTN	
			4.0	4.5	ARZXL6045N.MTN	
				6	ARZXL6046N.MTN	
				8	ARZXL6048N.MTN	

# ➔ ZrGEN Abutment Option

- Abutment Screw included.

- ✓ AnyRidge (AANMSF)
- ✓ BLUEDIAMOND NC (AROAS16B)
- ✓ BLUEDIAMOND RC (AROAS16)
- ✓ AnyOne Internal (AS20)
- ✓ ST Mini (OSGSAS3110)
- ✓ ST Regular (OSGSAS3210)

- Titanium base for CEREC users.
- In Lab CAD Software, compatible with Xive Library.
- 1 set consists of 10 Abutments.
  - included spare Abutment Screw.
- Recommend torque
  - 35Ncm : AnyRidge/ BLUEDIAMOND/ AnyOne Internal
  - 30Ncm : ST (Regular)
  - 20Ncm : ST (Mini)

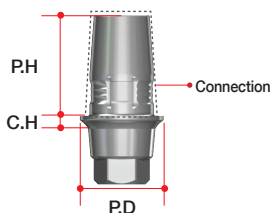

## C-type

System	Profile Diameter	Cuff Height (mm)	Post Height	Connection	Ref.C				
AnyRidge	Ø3.9	0.5	4.7	S	ARCS3405.MTN				
		1			ARCS3410.MTN				
		2			ARCS3420.MTN				
	Ø4.3	0.5			ARCS3805.MTN				
		1			ARCS3810.MTN				
		2			ARCS3820.MTN				
	Ø5.5	0.5		L	ARCL4505.MTN				
		1			ARCL4510.MTN				
		2			ARCL4520.MTN				
BLUE DIAMOND	Ø3.9	0.5	4.7	S	AROCSN3405.MTN				
		1.0			AROCSN3410.MTN				
		2.0			AROCSN3420.MTN				
		Ø4.3			0.5	AROCSN3805.MTN			
					1.0	AROCSN3810.MTN			
					2.0	AROCSN3820.MTN			
	Ø3.9	0.5		S	AROCSR3405.MTN				
		1.0			AROCSR3410.MTN				
		2.0			AROCSR3420.MTN				
		Ø4.3			0.5	AROCSR3805.MTN			
					1.0	AROCSR3810.MTN			
					2.0	AROCSR3820.MTN			
	Ø5.5	0.5		L	AROCLR4505.MTN				
		1.0			AROCLR4510.MTN				
		2.0			AROCLR4520.MTN				
		AnyOne Internal			Ø3.9	0.5	4.7	S	AOCS3405.MTN
						1			AOCS3410.MTN
						2			AOCS3420.MTN
Ø4.3	0.5		AOCS3805.MTN						
	1		AOCS3810.MTN						
	2		AOCS3820.MTN						
Ø5.5	0.5		L	AOCL4505.MTN					
	1			AOCL4510.MTN					
	2			AOCL4520.MTN					
ST	Ø3.9	0.5	4.7	S	STCSS3405.MTN				
		1			STCSS3410.MTN				
		2			STCSS3420.MTN				
		Ø4.3			0.5	STCSS3805.MTN			
					1	STCSS3810.MTN			
					2	STCSS3820.MTN			
	Ø3.9	0.5		S	STCSR3405.MTN				
		1			STCSR3410.MTN				
		2			STCSR3420.MTN				
		Ø4.3			0.5	STCSR3805.MTN			
					1	STCSR3810.MTN			
					2	STCSR3820.MTN			
	Ø5.5	0.5		L	STCLR4505.MTN				
		1			STCLR4510.MTN				
		2			STCLR4520.MTN				

## ➔ TiGEN Abutment Option (Continued)

### TiGEN Abutment

- Abutment Screw included.
  - ✓ AnyRidge (AANMSF)
  - ✓ BLUEDIAMOND NC (AROAS16B)
  - ✓ BLUEDIAMOND RC (AROAS16)
  - ✓ AnyOne Internal (AS20)
  - ✓ AnyOne External Small (SCS160)
  - ✓ AnyOne External Regular/ Wide (RCS200)
  - ✓ AnyOne Onestage (EXIMS100)
  - ✓ MiNi (MIAS14)
  - ✓ ST Mini (OSGSAS3110)
  - ✓ ST Regular (OSGSAS3210)
  - ✓ Octa Level (IRCS200)
- Pre-milled Abutment
- 1 set consists of 10 Abutments.
  - included spare Abutment Screw
- Supporting DentalCAD
  - 3 Shape
  - exocad
  - Dental Wings
- Supporting Milling Machine
  - MegaGen Implant : BX5
  - ARUM DENTISTRY
- Recommend torque
  - 35Ncm : AnyRidge/ BLUEDIAMOND/ AnyOne Internal/ AnyOne External (Regular & Wide)/ AnyOne Onestage/ Octa Level
  - 30Ncm : ST (Regular)
  - 25Ncm : AnyOne External (Small)
  - 20Ncm : ST (Mini)
  - 15Ncm : MiNi
- FDA : Approved in 2023

### Standard/ MegaGen type

System	Color	Profile Diameter	Height (mm)	Type	Ref.C		
AnyRidge	Gold	Ø10	20	Hex	ARTR1020.MTN		
				Non-Hex	ARTR1020N.MTN		
		Ø12		Hex	ARTR1220.MTN		
				Non-Hex	ARTR1220N.MTN		
BLUE DIAMOND	NC	Gold	20	Octa	AROTGN1020.MTN		
				Octa	AROTGN1220.MTN		
	RC	Silver		Octa	AROTGR1020.MTN		
				Octa	AROTGR1220.MTN		
		AnyOne Internal		Pink	Ø10	Hex	AOTR1020.MTN
					Ø12	Non-Hex	AOTR1020N.MTN
AnyOne External	S	Silver	20	Hex	AOTR1220.MTN		
				Non-Hex	AOTR1220N.MTN		
				Hex	AETS1020.MTN		
		R		Silver	Non-Hex	AETS1020N.MTN	
					Hex	AETS1220.MTN	
					Non-Hex	AETS1220N.MTN	
	W	Silver	20	Hex	AETR1020.MTN		
				Non-Hex	AETR1020N.MTN		
				Hex	AETR1220.MTN		
		W		Silver	20	Non-Hex	AETR1220N.MTN
						Hex	AETW1020.MTN
						Non-Hex	AETW1020N.MTN
AnyOne Onestage	Silver	Ø10	20	Hex		AETW1220.MTN	
				Non-Hex		AETW1220N.MTN	
MiNi	Silver	Ø10		Octa		AETW1220N.MTN	
				Non-Octa	AOOTR1020.MTN		
ST	Mini	Sky blue		20	Octa	AOOTR1220.MTN	
					Non-Octa	AOOTR1220N.MTN	
			Hex		MITN1020.MTN		
		Regular	Non-Hex		MITN1020N.MTN		
			Hex		OSTG3112.MTN		
			Non-Hex		OSTG3112N.MTN		
	Regular	Sky blue	20	Hex	OSTG3111.MTN		
				Non-Hex	OSTG3111N.MTN		
				Hex	OSTG3212.MTN		
		Regular		Silver	20	Non-Hex	OSTG3212N.MTN
						Hex	OSTG3211.MTN
						Non-Hex	OSTG3211N.MTN
Octa Level	Small	Silver	20	Octa		OSTG3211N.MTN	
				Non-Octa		OCTS1020.MTN	
				Octa		OCTS1220.MTN	
		Regular		Silver	20	Non-Octa	OCTS1220N.MTN
						Octa	OCTS1220.MTN
						Non-Octa	NOTS1020.MTN
	Wide	Silver	20	Octa		NOTS1220.MTN	
				Non-Octa		OCTR1020.MTN	
				Octa		OCTR1020.MTN	
		Wide		Silver	20	Non-Octa	NOTR1020.MTN
						Octa	NOTR1220.MTN
						Non-Octa	OCTW1020.MTN
Wide	Silver	20	Octa	OCTW1020.MTN			
			Non-Octa	NOTW1020.MTN			
			Octa	OCTW1220.MTN			
Wide	Silver		20	Non-Octa	NOTW1220.MTN		

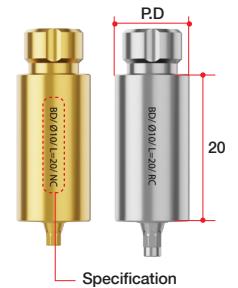

### Extra/ MegaGen type

System	Connection Fixture Core (Color)	Diameter	Profile Diameter	Height (mm)	Type	Ref.C		
AnyRidge	Bevel (Gold)	Ø3.3	Ø10	20	Hex	ARTXN1020.MTN		
					Non-Hex	ARTXN1020N.MTN		
					Hex	ARTXN1220.MTN		
		Platform (Light green)			Ø4.0	Ø10	Non-Hex	ARTXN1220N.MTN
							Hex	ARTXM1020.MTN
							Non-Hex	ARTXM1020N.MTN
	Platform (Light green)	Ø4.8	Ø10		Hex		ARTXM1220.MTN	
					Non-Hex		ARTXM1220N.MTN	
					Hex		ARTXL1020.MTN	
	Platform (Light green)	Ø4.8			Ø12	Non-Hex	ARTXL1020N.MTN	
						Hex	ARTXL1220.MTN	
						Non-Hex	ARTXL1220N.MTN	

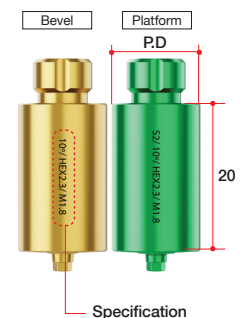

# ➔ TiGEN Abutment Option (Continued)



- Abutment Screw included.
  - ✓ AnyRidge (AANMSF)
  - ✓ BLUEDIAMOND NC (AROAS16B)
  - ✓ BLUEDIAMOND RC (AROAS16)
  - ✓ AnyOne Internal (AS20)
  - ✓ AnyOne External Small (SCS160)
  - ✓ AnyOne External Regular/ Wide (RCS200)
  - ✓ AnyOne Onestage (EXIMS100)
  - ✓ MiNi (MIAS14)
  - ✓ ST Mini (OSGSAS3110)
  - ✓ ST Regular (OSGSAS3210)
  - ✓ Octa Level (IRCS200)

- Pre-milled Abutment
- 1 set consists of 10 Abutments
  - included spare Abutment Screw
- Supporting DentalCAD
  - 3 Shape
  - exocad
- Recommend torque
  - 35Ncm : AnyRidge/ BLUEDIAMOND/ AnyOne Internal/ AnyOne External (Regular& Wide)/ AnyOne Onestage/ Octa Level
  - 30Ncm : ST (Regular)
  - 25Ncm : AnyOne External (Small)
  - 20Ncm : ST (Mini)
  - 15Ncm : MiNi
- FDA : Approved in 2023

## Standard/ NT type

System	Color	Profile Diameter	Height (mm)	Type	Ref.C	
AnyRidge	Gold	Ø10	16	Hex	ARTRN1016.MTN	
				Non-Hex	ARTRN1016N.MTN	
		Hex		ARTRN1216.MTN		
		Non-Hex		ARTRN1216N.MTN		
BLUE DIAMOND	NC (Gold)	Ø10		Octa	AROTGNN1016.MTN	
		Ø12		Octa	AROTGNN1216.MTN	
	RC (Silver)	Ø10		Octa	AROTGRN1016.MTN	
		Ø12		Octa	AROTGRN1216.MTN	
AnyOne Internal	Pink	Ø10	Hex	AOTRN1016.MTN		
		Ø12	Non-Hex	AOTRN1016N.MTN		
			Hex	AOTRN1216.MTN		
		Non-Hex	AOTRN1216N.MTN			
AnyOne External	S (Silver)	Ø10	Hex	AETSN1016.MTN		
			Non-Hex	AETSN1016N.MTN		
		Ø12	Hex	AETSN1216.MTN		
			Non-Hex	AETSN1216N.MTN		
	R (Silver)	Ø10	Hex	AETRN1016.MTN		
			Non-Hex	AETRN1016N.MTN		
		Ø12	Hex	AETRN1216.MTN		
			Non-Hex	AETRN1216N.MTN		
W (Silver)	Ø10	Hex	AETWN1016.MTN			
		Non-Hex	AETWN1016N.MTN			
	Ø12	Hex	AETWN1216.MTN			
		Non-Hex	AETWN1216N.MTN			
AnyOne Onestage	Silver	Ø10	Octa	AOOTRN1016.MTN		
			Non-Octa	AOOTRN1016N.MTN		
		Ø12	Octa	AOOTRN1216.MTN		
			Non-Octa	AOOTRN1216N.MTN		
MiNi	Silver	Ø10	Hex	MITNN1016.MTN		
ST	Mini	Sky blue	Ø10	Hex	OSTGN3112.MTN	
			Non-Hex	OSTGN3112N.MTN		
		Ø12	Hex	OSTGN3111.MTN		
			Non-Hex	OSTGN3111N.MTN		
	Regular	Sky blue	Ø10	Hex	OSTGN3212.MTN	
			Non-Hex	OSTGN3212N.MTN		
		Ø12	Hex	OSTGN3211.MTN		
			Non-Hex	OSTGN3211N.MTN		
Octa Level	Small	Silver	Ø10	Octa	OCTSN1016.MTN	
			Non-Octa	NOTSN1016.MTN		
		Ø12	Octa	OCTSN1216.MTN		
			Non-Octa	NOTSN1216.MTN		
		Regular	Silver	Ø10	Octa	OCTRN1016.MTN
				Non-Octa	NOTRN1016.MTN	
	Ø12		Octa	OCTRN1216.MTN		
			Non-Octa	NOTRN1216.MTN		
	Wide		Silver	Ø10	Octa	OCTWN1016.MTN
				Non-Octa	NOTWN1016.MTN	
		Ø12	Octa	OCTWN1216.MTN		
			Non-Octa	NOTWN1216.MTN		

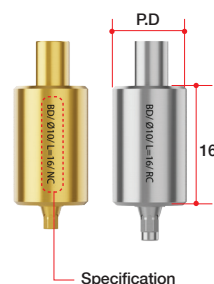

## Extra/ NT type

System	Connection Fixture Color	Core Diameter	Profile Diameter	Height (mm)	Type	Ref.C		
AnyRidge	Bevel (Gold)	Ø3.3	Ø10	16	Hex	ARTXNN1016.MTN		
					Non-Hex	ARTXNN1016N.MTN		
		Ø12			Hex	ARTXNN1216.MTN		
					Non-Hex	ARTXNN1216N.MTN		
		Platform (Light green)			Ø4.0	Ø10	Hex	ARTXMN1016.MTN
							Non-Hex	ARTXMN1016N.MTN
	Ø12		Hex		ARTXMN1216.MTN			
			Non-Hex		ARTXMN1216N.MTN			
	Ø4.8		Ø10		Hex	ARTXLN1016.MTN		
					Non-Hex	ARTXLN1016N.MTN		
		Ø12	Hex		ARTXLN1216.MTN			
			Non-Hex		ARTXLN1216N.MTN			

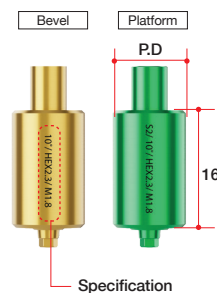

**NEW**

- Abutment Screw included.
  - ✓ AnyRidge (AANMSF)
  - ✓ BLUEDIAMOND NC (AROAS16B)
  - ✓ BLUEDIAMOND RC (AROAS16)
  - ✓ AnyOne Internal (AS20)
  - ✓ AnyOne External Small (SCS160)
  - ✓ AnyOne External Regular/ Wide (RCS200)
  - ✓ AnyOne Onestage (EXIMS100)
  - ✓ MiNi (MIAS14)
  - ✓ ST Mini (OSGSAS3110)
  - ✓ ST Regular (OSGSAS3210)
  - ✓ Octa Level (IRCS200)
- Pre-milled Abutment
- 1 set consists of 10 Abutments
  - included spare Abutment Screw
- Supporting DentalCAD
  - 3 Shape
  - exocad
- Recommend torque
  - 35Ncm : AnyRidge/ BLUEDIAMOND/ AnyOne Internal/ AnyOne External (Regular & Wide)/ AnyOne Onestage/ Octa Level
  - 30Ncm : ST (Regular)
  - 25Ncm : AnyOne External (Small)
  - 20Ncm : ST (Mini)
  - 15Ncm : MiNi
- FDA : Approved in 2023

**Standard/ Medentika type**

System	Color	Profile Diameter	Height (mm)	Type	Ref.C
AnyRidge	Gold			Hex	ARTRM1214.MTN
				Non-Hex	ARTRM1214N.MTN
BLUE DIAMOND	NC	Gold		Octa	AROTGNM1214.MTN
	RC	Silver		Octa	AROTGRM1214.MTN
AnyOne Internal	Pink			Hex	AOTRM1214.MTN
				Non-Hex	AOTRM1214N.MTN
AnyOne External	Silver			Hex	AETSM1214.MTN
				Non-Hex	AETSM1214N.MTN
				Hex	AETRM1214.MTN
				Non-Hex	AETRM1214N.MTN
				Hex	AETWM1214.MTN
				Non-Hex	AETWM1214N.MTN
AnyOne Onestage	Silver			Octa	AOOTRM1214.MTN
				Non-Octa	AOOTRM1214N.MTN
MiNi	Silver			Hex	MITNM1214.MTN
				Non-Hex	MITNM1214N.MTN
ST	Sky blue			Hex	OSTGM3111.MTN
				Non-Hex	OSTGM3111N.MTN
				Hex	OSTGM3211.MTN
				Non-Hex	OSTGM3211N.MTN
Octa Level	Silver			Octa	OCTSM1214.MTN
				Non-Octa	NOTSM1214.MTN
				Octa	OCTRM1214.MTN
				Non-Octa	NOTRM1214.MTN
				Octa	OCTWM1214.MTN
				Non-Octa	NOTWM1214.MTN

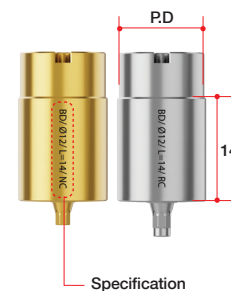

**Extra/ Medentika type**

System	Connection Fixture (Color)	Core Diameter	Profile Diameter	Height (mm)	Type	Ref.C
AnyRidge	Bevel (Gold)	Ø3.3	Ø12	14	Hex	ARTXNM1214.MTN
					Non-Hex	ARTXNM1214N.MTN
	Platform (Light green)	Ø4.0	Ø12	14	Hex	ARTXMM1214.MTN
					Non-Hex	ARTXMM1214N.MTN
					Hex	ARTXLM1214.MTN
					Non-Hex	ARTXLM1214N.MTN



# ➔ TiGEN Abutment Option



- Abutment Screw included.
  - ✓ AnyRidge (AANMSF)
  - ✓ BLUEDIAMOND NC (AROAS16B)
  - ✓ BLUEDIAMOND RC (AROAS16)
  - ✓ AnyOne Internal (AS20)
  - ✓ ST Mini (OSGSAS3110)
  - ✓ ST Regular (OSGSAS3210)
- Pre-milled Abutment
  - Pre-milled part : Implant Connection + Cuff (0.6/ 1.5/ 3.0mm)
- 1 set consists of 10 Abutments
  - included spare Abutment Screw
- Used by fastening it to a reverse jig
- Supporting Dental CAD
  - 3 Shape
  - exocad
- Supporting Milling Machine
  - MegaGen Implant : BX5
  - ARUM DENTISTRY
- Recommend torque
  - 35Ncm : AnyRidge/ BLUEDIAMOND/ AnyOne Internal
  - 30Ncm : ST (Regular)
  - 20Ncm : ST (Mini)
- FDA : Approved in 2023
- CE : Approved in 2024

## CUFF type

System	Color	Profile Diameter	Cuff Height (mm)	Height (mm)	Type	Ref.C						
AnyRidge	Gold	Ø8	0.6	16	Hex	ARTRR0608.MTN						
			1.5			ARTRR1508.MTN						
			3.0			ARTRR3008.MTN						
		Ø10	0.6			ARTRR0610.MTN						
			1.5			ARTRR1510.MTN						
			3.0			ARTRR3010.MTN						
	Ø12	0.6	ARTRR0612.MTN									
		1.5	ARTRR1512.MTN									
		3.0	ARTRR3012.MTN									
	BLUEDIAMOND	NC	Ø8			0.6	16	Octa	BDTGNR0608.MTN			
						1.5			BDTGNR1508.MTN			
						3.0			BDTGNR3008.MTN			
Ø10			0.6	BDTGNR0610.MTN								
			1.5	BDTGNR1510.MTN								
			3.0	BDTGNR3010.MTN								
Ø12			0.6	BDTGNR0612.MTN								
			1.5	BDTGNR1512.MTN								
			3.0	BDTGNR3012.MTN								
RC			Silver	Ø8	0.6	16			Octa	BDTGRR0608.MTN		
					1.5					BDTGRR1508.MTN		
					3.0					BDTGRR3008.MTN		
		Ø10		0.6	BDTGRR0610.MTN							
				1.5	BDTGRR1510.MTN							
				3.0	BDTGRR3010.MTN							
		Ø12	0.6	BDTGRR0612.MTN								
			1.5	BDTGRR1512.MTN								
			3.0	BDTGRR3012.MTN								
		AnyOne Internal	Pink	Ø8	0.6					16	Hex	AOTRR0608.MTN
					1.5							AOTRR1508.MTN
					3.0							AOTRR3008.MTN
Ø10				0.6	AOTRR0610.MTN							
				1.5	AOTRR1510.MTN							
				3.0	AOTRR3010.MTN							
Ø12	0.6			AOTRR0612.MTN								
	1.5			AOTRR1512.MTN								
	3.0			AOTRR3012.MTN								

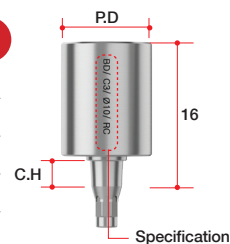

CUFF type

System	Color	Profile Diameter	Cuff Height (mm)	Height (mm)	Type	Ref.C		
ST	Mini	Ø8	0.6	16	Hex	OSTGMR0608.MTN		
			1.5			OSTGMR1508.MTN		
			3.0			OSTGMR3008.MTN		
		Ø10	0.6			OSTGMR0610.MTN		
			1.5			OSTGMR1510.MTN		
			3.0			OSTGMR3010.MTN		
		Ø12	0.6			OSTGMR0612.MTN		
			1.5			OSTGMR1512.MTN		
			3.0			OSTGMR3012.MTN		
		Regular	Sky blue			Ø8	0.6	OSTGRR0608.MTN
							1.5	OSTGRR1508.MTN
							3.0	OSTGRR3008.MTN
	Ø10		0.6	OSTGRR0610.MTN				
			1.5	OSTGRR1510.MTN				
			3.0	OSTGRR3010.MTN				
	Ø12		0.6	OSTGRR0612.MTN				
			1.5	OSTGRR1512.MTN				
			3.0	OSTGRR3012.MTN				

[TiGEN Abutment CUFF type Line-Up]

	D8	D10	D12
C0.6			
C1.5			
C3.0			

► CUFF types of TiGEN Abutment have same form of cuff shape as the Scan Healing Abutment thus custom abutment with perfectly fit to emergence profile can be fabricated

· Various cuff sizes for every gingiva height

► Pre-milled cuff reduces milling time + precision is increased with reverse jig milling

- 60% reduction in milling time when compared with conventional products!
- NO post milling, allowing reverse jig milling to occlusal surface within 8 minutes!

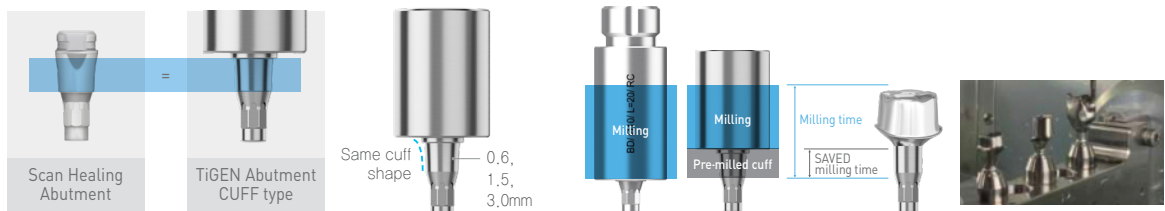



# ➔ Reverse Jig Connector Option

## Reverse Jig Connector

- Milling screws exclusively for Reverse Jig Connector are included
  - ✓ AnyRidge (ARRJMS)
  - ✓ BLUEDIAMOND NC/ RC (BDRJMS)
  - ✓ AnyOne Internal (AORJMS)
  - ✓ ST Mini (STRJMSM)
  - ✓ ST Regular (STRJMSR)
- Do not use Non-Engage(Hex/ Octa)
- System can be checked by the number of Groove
  - AnyRidge → Groove 1ea
  - BLUEDIAMOND NC → Groove : narrow 2ea
  - BLUEDIAMOND RC → Groove : wide 2ea
  - AnyOne Internal → Groove : 0ea
  - ST Mini → Groove : narrow 3ea
  - ST Regular → Groove : wide 3ea
- Available milling machines
  - MegaGen Implant : BX5
  - ARUM DENTISTRY
- Recommended Torque
  - 35Ncm
  - Dedicated Driver (DP-RV-TORQ-DRV) (option)
- When Connected counterpart to Reverse Jig use Allen Wrench
  - Allen Key Size : 2.5mm
  - Dedicated Wrench (DP-HEX-TWLENCH) (option)

System	Type	Ref.C
AnyRidge	Hex	ARTGRJ00P
BLUE DIAMOND	NC	BDTGRJN00P
	RC	BDTGRJR00P
AnyOne Internal	Hex	AOTGRJ00P
ST	Mini	STTGRJM00P
	Regular	STTGRJR00P

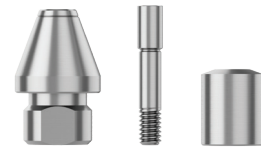

\*An example of grooves for different systems

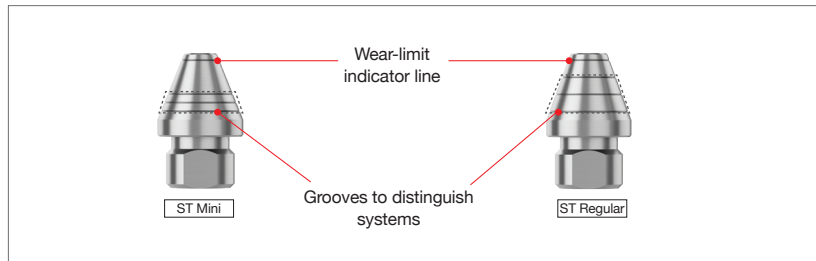

\*Reverse Jig Connector assembly Option

